

~~SECRET~~ ID: A56970
~~CONFIDENTIAL~~
~~SECURITY INFORMATION~~

William J. Friedman
2/14/53

**DEPARTMENT OF THE ARMY
OFFICE OF THE CHIEF OF MILITARY HISTORY**

~~REGRADED SECRET~~

MS No P-038

**By authority of ACoS, G-2, by
ORLANDO WARD, Maj. Gen.,
Chief of Military History,
22 January 1953,**

**GERMAN RADIO
INTELLIGENCE**

**ORIGINALLY PREPARED FOR HISTORICAL DIVISION
HEADQUARTERS EUROPEAN COMMAND**

~~SECRET~~
~~CONFIDENTIAL~~
~~SECURITY INFORMATION~~

~~SECRET~~ ID: A56970
~~SECRET~~
~~CONFIDENTIAL~~
~~Security Information~~

MS # P-038

Albert Praun
Former General der
Nachrichtentruppe
(Lieutenant General)

Neumarkt - St. Veit
March 1950

GERMAN RADIO INTELLIGENCE

TRANSLATION

~~SECRET~~
~~CONFIDENTIAL~~
~~Security Information~~

~~CONFIDENTIAL~~
~~Security Information~~

Biographical Sketch of the Principal Author

Albert PRAUN was born 11 December 1894 in Bad Gastein, Austria. He entered the German Army in the 1st Bavarian Telegraph Battalion as an officer candidate in 1913 and served as battalion and division signal officer during World War I. He remained in the post-war Army and in 1939 was assigned to the Seventh Army on the Western Front as army signal officer.

During World War II PRAUN served as regimental, brigade, and division commander, and also as army and army group signal officer in France and Russia. In 1944 he was promoted to the rank of Lieutenant General and simultaneously appointed Chief of Army and Armed Forces Signal Communication, in which capacity he remained until the end of hostilities.

~~CONFIDENTIAL~~
~~Security Information~~

~~CONFIDENTIAL~~~~Security Information~~

MS # P-038

List of Other Contributors

(Last rank held and assignments relative to the present subject)

de Bary Major, commander of radio intercept units.

Bode Captain, intercept platoon leader; chief of the clearing center of Communication Intelligence West.

Gimmler Major General, Chief Signal Officer under the Commander
*
in Chief West and Chief of the Armed Forces Signal

*

Tr: Oberbefehlshaber, hereafter referred to as OB

Communication Office.

Gorzolla Captain, liaison officer between the clearing center of communication intelligence and the Eastern Intelligence Branch.

Halder Colonel, commander of intercept troops for an army group.

Henrici Lieutenant colonel, General Staff, chief signal officer for OB West.

Hepp Colonel, General Staff, Deputy Chief of Army Signal Communication.

Karn Colonel, army signal officer.

Kopp Colonel, senior communication intelligence officer for OB West.

de Leliwa Lieutenant colonel, chief of evaluation for OB West.

~~CONFIDENTIAL~~~~Security Information~~

~~CONFIDENTIAL~~~~Security Information~~

MS # P-038

Marquardt Major, liaison officer between the clearing center of communication intelligence and the Western Intelligence Branch, Army General Staff.

Mettig Major, chief of the cryptanalysis section of the main intercept station.

Muegge Colonel, communication intelligence officer for an army group.

Poppe Major, signal battalion commander.

Randewig Colonel, commander of intercept units with various army groups.

Seemueller Lieutenant colonel, communication intelligence officer for several army groups.

Stang Captain, radio company commander, armored divisions.

~~CONFIDENTIAL~~~~Security Information~~

~~CONFIDENTIAL~~~~Security Information~~

MS # P-038

List of Charts

<u>No.</u>	<u>Page</u>
1. Operations of Communication Intelligence Units Against the Balkans and the Near East February 1941	12
2. Radio Intelligence During the Norwegian Campaign 31 March - 14 June 1940	16
3. Operations by Intercept Units August 1939 - May 1940	20
4. Radio Intelligence Findings During the French Campaign May - June 1940	32
5. Radio Intelligence Operations Against Great Britain July 1940 - January 1941	40
6. Radio Intelligence Operations in the Mediterranean Theater March 1943	56
7. Communication Circuits used by Intercept Units March 1943	62
8. Organization of Radio Intelligence Units under OB West a) At the Start of the Invasion b) After 1 January 1945	73
9. Operations of Radio Intelligence in Southern Russia 1941 - 42	89
App. I	
1. Development of the Radio Intercept Service 1921 - 39	157
App. IV	
1. Organization of Radio Counterintelligence 1941 - 45	198
2. Radio Intercept Company (Mtz) Operating Procedure 1941 - 42	198
3. Radio Counterintelligence Operations 1941 - 42	199
4. Radio Counterintelligence Procedure Instituted in 1943	200
5. Agent-Operated Radio Stations Observed and Plotted in 1943 - 44	205
App. VI	
1. Allocation of Responsibility for Communication Intelligence Operations	240

~~CONFIDENTIAL~~~~Security Information~~

~~CONFIDENTIAL~~~~Security Information~~

MS # P-038

Table of Contents

	<u>Page</u>
Biographical Sketch of the Principal Author	i
List of Other Contributors	ii
List of Charts	iv
Chapter One. Introduction	1
Chapter Two. The Significance of Electronic Warfare	3
Chapter Three. German Radio Intelligence Operations (1936 - 45)	
I. Spanish Civil War (1936 - 39)	6
II. Czechoslovakia (1938)	6
III. Polish Campaign (1939)	7
IV. USSR (1939 - 40)	9
V. German Campaign in the Balkans (1941)	11
VI. Norway and Denmark (1940)	15
VII. Campaign in the West (1940)	20
VIII. Intercept Operations Against Great Britain (1940 - 41)	36
IX. Intercept Operations Against Great Britain and the U.S. (1942)	44
X. Africa and the Near East (1941 - 43)	51
XI. Sicily and Italy (1943 - 45)	64
XII. Defense of Western Europe (1944 - 45)	72
XIII. Russian Front (1941 - 45)	86
Chapter Four. Appraisal of Radio Communication in Belligerent Armies Committed in the European Theater	
I. The Russian Army	130
II. The British Army	135
III. The US Army	139
IV. The German Army	142
V. Others	143
VI. Summary and Conclusions	145
Chapter Five. Radio Intelligence Activity of the German Armed Forces High Command -- Conclusions	147

~~CONFIDENTIAL~~~~Security Information~~

~~CONFIDENTIAL~~
~~Security Information~~

MS # P-038

<u>Table of Contents (Cont.)</u>		<u>Page</u>
Appendix	I. Historical Survey of German Radio Intelligence	
	1. 1914 - 18	151
	2. 1918 - 36	155
	3. 1936 - 39	161
	4. 1939 - 45	170
Appendix	II. Survey of the Technological Evolution of German Radio Intelligence	182
Appendix	III. Basic Elements of Radio Intelligence	
	1. Interception	186
	2. Direction Finding	189
	3. Evaluation	190
Appendix	IV. Radio Counterintelligence	
	1. Amateur Radio Activity	195
	2. Radio Agents in Occupied Countries	196
	3. Organization	198
	4. Operating Procedure	200
	5. Results	
	a. Against Agents	204
	b. Against Partisans	206
	aa. The Soviet Union	
	bb. Poland	
	cc. The Balkans	
	6. Appraisal of Allied Subversive Radio Activities	217
Appendix	V. Cryptanalysis	220
Appendix	VI. Appraisal of Short-Range Communication Intelligence	233
Appendix	VII. German Intercept Equipment	241
	1. Receivers	
	2. Antenna Amplifiers	
	3. Wave Indicators	
	4. Recording Devices	
	5. Direction Finders	
Appendix	VIII. Transcript of an Intercept Made by the RI Unit of the 252d Infantry Division in the Gzhatsk Area on 24 February 1943	252

~~CONFIDENTIAL~~
~~Security Information~~

~~SECRET~~
~~CONFIDENTIAL~~

Security Information

MS # P-038

-1-

Chapter One

INTRODUCTION

Because of the difficulties encountered in this highly specialized field the topic required treatment by an expert of recognized standing. Since such an expert was not available among the men in the German Control Group working under the supervision of the Historical Division, EUCOM, the writing of the over-all report was assigned to General Praun. By virtue of the knowledge acquired by him in his military career, and especially during the tenure of his final position, General Praun has a thorough grasp of German radio intelligence. Moreover, as a result of his acquaintance with German signal service personnel, he was able to obtain the co-operation of the foremost experts in this field.

The German Control Group has exerted a guiding influence on the study by issuing oral and written instructions concerning the manner in which the subject was to be handled. Above all, it reserved to itself the right of final decision in the selection of the contributors and also retained control over the individual reports themselves.

With regard to the treatment of the topic assigned, General Praun, with the approval of the Control Group, decided to make his report in the form of a study in military history. Since no comprehensive records were available, he assembled the basic material for the various theaters of war and the most important campaigns by enlisting the aid of signal officers who had served in radio intelligence in the respective theaters. This material was supple-

~~SECRET~~
~~CONFIDENTIAL~~

Security Information

~~CONFIDENTIAL~~
Security Information

MS # P-038

-2-

mented by reports from officers who had held important positions as experts
in various branches of radio intelligence in the Army High Command * and the
Armed Forces (Wehrmacht) High Command **. From the successes and failures

/Tr: * Oberkommando des Heeres, hereafter referred to as OKH; ** Oberkommando der Wehrmacht, hereafter referred to as OKW/

of German radio intelligence General Praun has established criteria for appraising the enemy radio services. He is thus able to present an actual picture of the Allied radio services as seen from the German side during the war.

An attempt was made to include an account of all major American and British military operations against the German Army, and an appraisal of their use of radio communication. The material on Russia was treated in a different manner. Because of the vastness of the Russian theater of war and because the same observations concerning radio communication were made along the entire front, the results obtained by communication intelligence units serving with only one army group have been described. They are supplemented by accounts from other sectors of the Russian front.

In keeping with German practice since 1942, the term "communication intelligence" (Nachrichtenaufklaerung) has been used when units thus designated were assigned to observe enemy radio and wire communication. (The latter activity lost almost all importance as compared with the former.) Where the observation of enemy radio communication alone is discussed, the term "radio intelligence" (Funkaufklaerung) is used or -- as was customary until 1942 -- the term "intercept service" (Horchdienst).

~~CONFIDENTIAL~~
Security Information

~~CONFIDENTIAL~~
-Security Information-

MS # P-038

-3-

Chapter Two

The Significance of Electronic Warfare

Toward the end of World War I about 12,000 signal troops of the German Army were engaged in intercepting the radio traffic of an increasingly powerful enemy. With the decline of the information gained by intelligence through aerial observation, prisoner of war interrogations, and reports from enemy agents, communication intelligence became increasingly important. In spite of the constant attempts of the enemies to improve radio communication and increase its security, German signal troops were able again and again to gain access to the information transmitted by this medium.

Thanks to communication intelligence, German commanders were better informed about the enemy and his intentions than in any previous war. This was one of the factors which gave the German command in the various campaigns of World War II a hitherto unattained degree of security. The fact that, during the final years of the war when the German Army Command was leading exhausted and decimated troops without reserves, it was able to offer less and less resistance to clearly recognized measures and intentions of the Allies, and that Hitler was unwilling to acknowledge the true situation on all fronts and the growing enemy superiority as reported in accurate detail by communication intelligence, is one of the deep tragedies of the German soldier.

Since wireless telegraphy and later wireless telephony were first used for military communication, there was no pause in the eventful contest between this important instrument of the German command (and subsequently

~~CONFIDENTIAL~~
-Security Information-

~~CONFIDENTIAL~~
~~Security Information~~

MS # P-038

-4-

also of troop units) on the one hand, and the corresponding facilities of the enemy on the other, as each side tried to profit from his knowledge of the other's communications as he prepared his countermeasures.

Following the first amazing successes scored by radio intelligence of a high-level nature in World War I, the quantity of information obtained, including that pertaining to tactical operations, increased so enormously with the amount of radio apparatus used by all the belligerent powers that large-sized organizations had to be established for handling them.

The active radio services in all armies tried to insure the secrecy of their messages by technical improvements, by speed in operation, by changing their procedure, by more complicated cipher systems, by accuracy in making calls and replies and in transmitting other signals, all of which constituted "radio discipline." However, in opposition to these developments the enemy also improved his passive radio service, his technical equipment, his methods of receiving, direction finding, and cryptanalysis. The important part played in this contest by the proficiency of the technical personnel involved will be described later.

At the same time that this form of electronic warfare was being waged in World War II, there was another aspect which also gained steadily in importance, namely, the more technical high frequency war between opposing radar systems. This consisted of the use of microwaves for the location and recognition of enemy units in the air and on the sea, and the adoption of defensive measures against them, especially in air and submarine warfare.

For the sake of completeness there should also be mentioned the third aspect of electronic warfare, the "radio broadcasters' war" in which propaganda

~~CONFIDENTIAL~~
~~Security Information~~

~~CONFIDENTIAL~~
~~Security Information~~

MS # P-038

-5-

experts tried to influence enemy as well as other countries, by means of foreign language broadcasts over increasingly powerful transmitters.

All three aspects of this modern "cold war of the air waves" were carried on constantly even when the guns were silent. This study will be restricted to a description of the first aspect of electronic warfare.

~~CONFIDENTIAL~~
~~Security Information~~

MS # P-038

-6-

Chapter Three

German Radio Intelligence Operations (1936 - 45)

In addition to the intelligence gained from intercepting the routine radio traffic in peacetime and the occasional activity during maneuvers, the political and military events which preceded the outbreak of World War II offered abundant material because of the increased traffic between the nations concerned, the larger number of messages, and the refinements and deficiencies in communication systems which had hitherto not come to light. During this period the German communication intelligence organization and the specialists employed in it gathered a wealth of information. Without any lengthy experimentation they were later on able to solve the increasing number of new problems which resulted from the extension of the war.

I. Spanish Civil War (1936 - 39)

In the Spanish Civil War the supporting powers on both sides had opportunities to become acquainted with the radio systems, radio equipment, and cryptographic methods of their opponents. The German intercept company assisting Franco obtained much information on these subjects. Because of its successes this company was always assigned to the focus of the military operations.

II. Czechoslovakia (1938)

For a long time the entire radio net traffic of Czechoslovakia was easy to intercept and evaluate. It was observed by fixed listening posts and intercept companies in Silesia and Bavaria, subsequently also by stations in

~~CONFIDENTIAL~~
~~Security Information~~

MS # P-038

-7-

Austria. Toward the end of May 1938 one of the key radio stations in Prague, probably that of the War Ministry, suddenly transmitted a brief, unusual message which, in view of the existing political tension, was believed to be an order for mobilization. This message was immediately followed by changes in the radio traffic characterized by the use of new frequencies and call signs, and by the regrouping of radio nets which had been prepared for the event of mobilization. The result was that the intercept company then on duty was able within two and a half hours to report the mobilization of Czechoslovakia. During the next few days very primitive, simple radio nets appeared along the border and then disappeared again when the tension was relaxed, whereupon the entire radio net reassumed its original characteristics. Radio intelligence was able to report that the mobilization order had presumably been revoked.

In the middle of September of the same year something incredible happened. The Czechs repeated what they had done in the spring. Again they announced the mobilization order by radio and within a few minutes the message was forwarded to Berlin. Again the same primitive radio nets appeared along the border with almost the same call signs and on the same frequencies.

This intercept operation was a practical object lesson, while the radio service of the Czechs was a classical example of how not to carry on radio operations.

III. Polish Campaign

Polish radio communications were also well known, as the result of long observation, and were intercepted from points in Silesia and East Prussia. During the period of tension in the summer of 1939 the Germans observed not

~~CONFIDENTIAL~~
~~Security Information~~

~~CONFIDENTIAL~~
~~—Security Information—~~

MS # P-038

-8-

only the regular traffic but also a great number of field messages which increased daily and was far out of proportion to the known organization and radio equipment possessed by the Polish Army. As was soon conjectured and then later confirmed during hostilities, the purpose of this was to camouflage Polish radio communications by using three call signs and three frequencies for each station. Intelligence officers engaged in the evaluation of traffic and D/F data were unable to derive any detailed tactical picture from the intercepted messages. Nevertheless, the intercept service confirmed that the Polish assembly areas were located where the German General Staff had assumed them to be. It can no longer be determined whether the Poles employed these artifices for purposes of deception, as well as camouflage, in order to simulate stronger forces than they actually possessed. In any case, the failure to observe radio silence in the assembly areas was a grave mistake.

In 1939 the mobile facilities of the German intercept service were still inadequate. The intercept companies were insufficiently motorized and there was no close co-operation between them and the army group and army headquarters. The Polish radio communication system failed after the second day of the campaign, when it attempted to take the place of the wire lines destroyed by German air attacks. Probably as a result of the intercept successes they had scored in 1920, the Poles had restricted their peacetime radio activity to a minimum. As soon as they tried to carry out deception without previous practice in mobile operations, their radio communication collapsed completely. It was unable to keep pace with the rapid movements of the retreat, and moreover, the Poles were seized by the

~~CONFIDENTIAL~~
~~—Security Information—~~

~~CONFIDENTIAL~~
~~Security Information~~

MS # P-038

-9-

same type of radio panic that will be discussed later in the section on the Allied invasion in Normandy. Clear-text messages revealed that many stations no longer dared to transmit at all, fearing they would be located by our direction finders and attacked from the air.

The Polish Army was thus unable to employ its radio communication for command purposes. Its leading source of information regarding the situation at the front were the OKW communiqués, which, at that time, accurately reported every detail with typical German thoroughness. This mistake was corrected in the German campaign in the West in 1940. Intercept results were insignificant, since the Poles transmitted hardly any radio messages. The messages of some individual units were intercepted until these disbanded at the Galician-Romanian border. It was possible to solve several simple field ciphers even without trained cryptanalysts. Another mistake made by the Poles was the transmission of messages in the clear by the station of the Military Railway Transportation Office in Warsaw, which openly announced the time, route, and contents of railway shipments. These trains were successfully attacked by the Luftwaffe, which was further aided by other plain-text Polish traffic.

IV. USSR (1939 - 40).

After the conclusion of the Polish Campaign, the intercept company stationed in Galicia in the Sanok - Jaroslav - Sandomir area was charged with intercepting the traffic emanating from Russian units occupying eastern Poland. Thanks to their previous experience against Czechoslovakia and Poland, personnel of this company were so well trained that they rapidly became skilled in this new type of work. This company was not

~~CONFIDENTIAL~~
~~Security Information~~

MS # P-038

-10-

engaged in cryptanalysis. Solely on the basis of D/F reports and an evaluation of the procedure and traffic characteristics of the heavy traffic handled by the numerous stations, the Germans were able to deduce that a large number of troop units were in the area, but were at first incapable of ascertaining their organizational structure. All that could be determined was whether these units belonged to the army, the air force or to the NKVD^{*}, whose radio operations were distinguished by a different technique

*
Tr: Commissariat of Internal Affairs, see TM 30-430, I-267

from that used by the regular armed forces. For several months during the period of regroupment everything was in a state of flux. The Soviet radio traffic was, however, well organized and efficiently handled.

Then the company intercepted messages from areas which were not actually assigned to it. When Soviet troops occupied the Baltic states of Estonia, Latvia and Lithuania, and when they subsequently attacked Finland, their short-wave transmissions from these areas were surprisingly well received in southern Galicia — even better than in areas further north. This was a discovery of great technical importance for the German intercept service. It could not have been arrived at by simple calculation since it resulted from physical conditions.

An abundance of messages, often in the clear, were received from the Baltic states and the Finnish theater of war, so that in the final stages of evaluation it was now possible to deduce the Soviet order of battle. In the case of units of division size and below their withdrawal from the Baltic States was frequently ascertained on the basis of data including numbers, names of officers, and place names. Subsequently these elements turned up

~~CONFIDENTIAL~~
~~Security Information~~

MS # P-038

-11-

on the Finnish front in easily identified locations, from where they again disappeared after a while, only to reappear in the Baltic area or eastern Poland. Some vanished from observation altogether. From this fact it could be deduced that they had been transferred to the interior of the Soviet Union. Thus, the Germans could follow all movements of forces during the Russo-Finnish War simply by reading the intercept situation chart.

The radio communication of the Soviet Army in 1939 - 40 was efficient and secure under peacetime conditions, but in time of war, or under war-like conditions, it offered many weak spots to an enemy intercept service and was a source of excellent information for the German intelligence service.

V. German Campaign in the Balkans (1941)

Since the results obtained from radio interception during the German campaign against Yugoslavia, Greece and the British Expeditionary Force are not of any special importance for an over-all appraisal of the subject, the campaign in the Balkans will be introduced at this point as one of the events preceding the beginning of major operations.

The German Army's organization for mobile warfare was still incomplete; results were jeopardized at first by the great distances between the intercept stations and the target areas, and later on by defective signal communication which delayed the work of evaluation. Intercept operations against the British will be described in detail in section VIII, pp. 36-44.

The Commander of Intercept Troops Southeast, whose headquarters is indicated in Chart 1 as being that of a regiment, was responsible to Field Marshal List, the Twelfth Army Commander. He was in charge of the two fixed

~~CONFIDENTIAL~~
~~Security Information~~

~~CONFIDENTIAL~~
Security Information

MS No P-038 Chart I

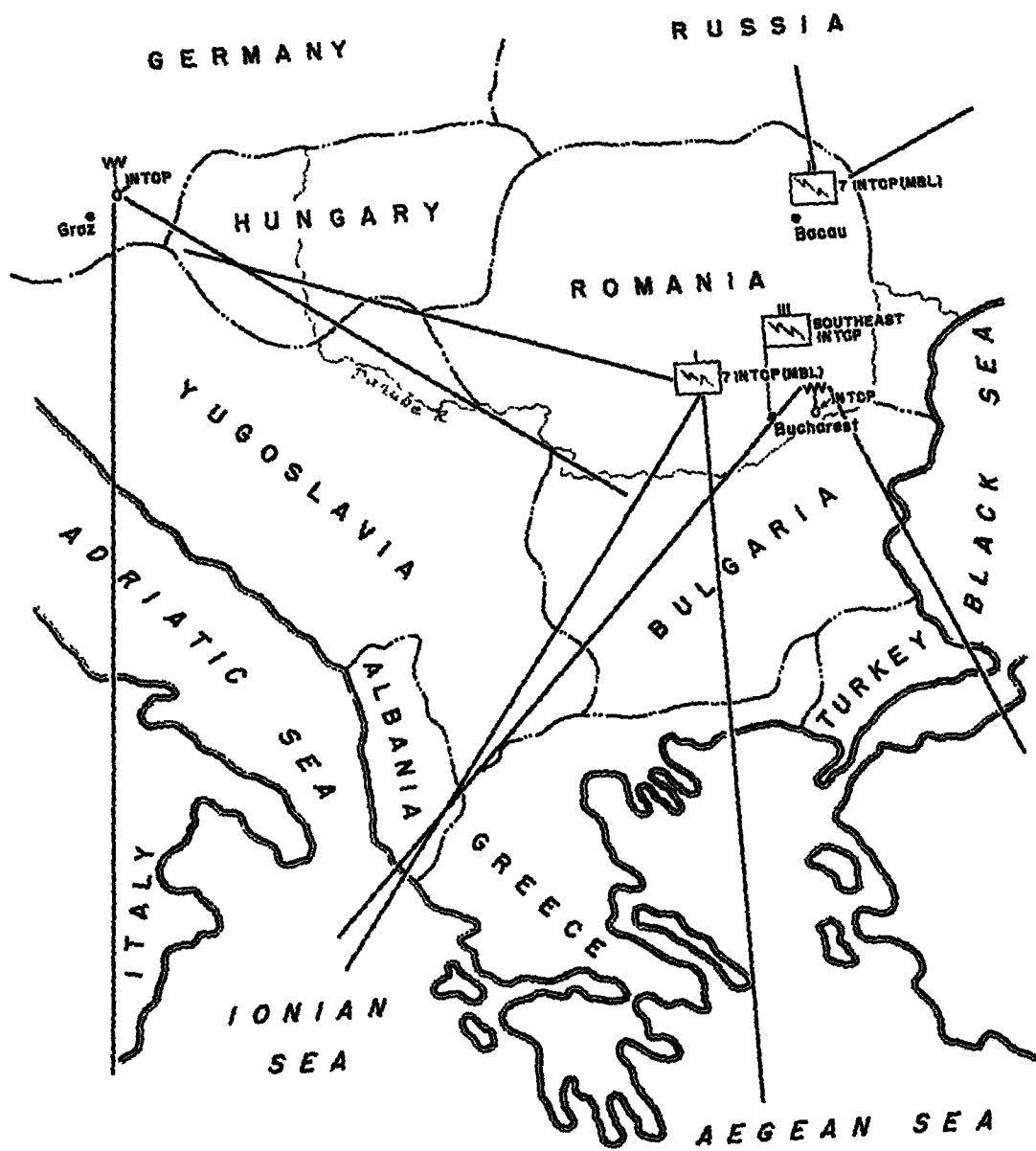

MEDITERRANEAN SEA

OPERATIONS OF COMMUNICATION INTELLIGENCE UNITS
AGAINST THE BALKANS AND NEAR EAST
FEBRUARY 1941



~~CONFIDENTIAL~~
Security Information

~~CONFIDENTIAL~~
~~Security Information~~

MS # P-038

-12-

intercept stations in Graz and Tulln (near Vienna) and two intercept companies. His sphere of action comprised the entire Balkan Peninsula, Turkey, and the British forces in Greece and the Middle East.

Until late 1940 radio interception against Greece and the Near East was carried out only as a secondary task and with insufficient resources by the Tulln station. The great distances, for instance 780 miles between Vienna and Athens and 1,440 miles between Vienna and Jerusalem, were a significant factor. (For purposes of comparison with intercept operations in the West it might be mentioned that the distance between Muenster and London is only 312 miles.) The value of the results was in inverse proportion to the distance involved.

In the beginning of 1941, when it was planned to enlarge the intercept service against Greece, especially after the landing of the British forces, the above-mentioned units, except for the Graz station, were transferred to Romania. In February 1941 the Commander of Intercept Troops Southeast and his evaluation center were stationed in Bucharest. From a location near this city the "Tulln station" covered Greece, giving its main attention to British communications emanating from there and the Middle East. One of the intercept companies also located in the vicinity of Bucharest observed Yugoslavia in addition to British radio traffic in Greece. The other intercept company in Bacau (150 miles northeast of Bucharest) had to carry out intercept operations against Soviet Russia and the Romanian police, whereas the Graz station, whose main attention was directed at Yugoslavia and Italy, intercepted traffic of the Romanian and Hungarian police. (See Chart 1)

~~CONFIDENTIAL~~
~~Security Information~~

~~CONFIDENTIAL~~
~~Security Information~~

MS # P-038

-13-

Before the outbreak of hostilities in the Balkans the Germans detected Greek army units in the northeastern corner of the country, Royal Air Force operations around Patras and between Patras and Athens, and British ground forces in Cyrenaica. They also intercepted messages from British border troops in Transjordan.

After the entry of German troops into Bulgaria the above-mentioned units (except the Graz station) were transferred to that country, and the intercept company in Bacau also covered Greece. The results were similar to those formerly obtained. It was not yet possible, however, to break the Greek ciphers because of an insufficient number of intercepted messages, and the German units had to be content with traffic analysis. On the other hand, it was possible to break the British field cipher in Palestine.

Following the attack upon Greece on 6 April brisk radio traffic was intercepted and evaluated. The disposition of the Greek forces in northern Greece was revealed and could be traced. West of the Vardar in the British Expeditionary Force sector, our intercept units detected three radio nets comprising fourteen stations, representing an armored unit northeast of Veria which was subsequently transferred to the area south of Vevi, a British division north of Katerini, and another division west of Demetrios. It was confirmed that these forces had remained for several days in the areas reported. On 8 April, the following British message in clear text was repeatedly heard: "DEV reporting from LIJA -- Strumica fallen, prepare immediate return!"

In the Near East we followed the movement of a British regiment from Palestine to Egypt. The first indication of this was the message of a

~~CONFIDENTIAL~~
~~Security Information~~

~~CONFIDENTIAL~~
Security Information

MS # P-038

-14-

paymaster in the British military government ordering a certain agency to be particularly careful to prevent the departing regiment from taking any filing cabinets along with it, since they were needed by the military government office. Thereafter, the regiment's movements could be clearly traced.

Radio intelligence against Yugoslavia produced an excellent picture of enemy positions. Three Armeegruppen * and one corps from each were

* Tr: a weak improvised army under an army commander with an improvised army staff

located near Nish, Ueskueb and Stip, and later one at Veles.

Very little radio traffic was heard in Turkey. By the middle of April German radio intelligence located Greek troop units between the Aliakmon River and the Albanian border, and also followed the withdrawal of a British armored unit from the vicinity of Vevi to the Kozani area, subsequently to Elefthorion, and thence to Trikkala. The withdrawal of both British divisions (Anzac Corps) and, a few days later, further withdrawals to the area of Larisa were observed.

In the middle of April the Commander of Intercept Troops Southeast moved to the Salonika area with the "Tulln station," elements of the Graz station, and one intercept company. The other intercept company was released for service in Russia.

Greek radio traffic diminished rapidly and ended with the capitulation on 21 April. German intercept units continued to follow the traffic of the British Expeditionary Force until it disappeared from the air after the final embarkation in late April. The intercepting of British traffic

~~CONFIDENTIAL~~
Security Information

MS # P-038

-15-

from Crete and the Aegean islands was continued. During subsequent British operations in the Dodecanese Islands, for instance the occupation of Rhodes, the enemy often transmitted important situation reports in the clear.

VI. Norway and Denmark (1940)

The mobile operation of an intercept platoon in the Norwegian Campaign in 1940 suffered from all the defects inherent in inadequately prepared improvised operations. A few radio operators were picked from each of six different units in the West, but no translators or cryptanalysts. The equipment was also inadequate. Later on, there was no shipping space to move the platoon up in time and close enough to the German operations staff and the enemy area which was to be covered, nor was the platoon given any data or instructions.

In its first operation, which was carried out with the assistance of the Husum Fixed Intercept Station, the platoon intercepted only coastal defense messages in clear text from Denmark concerning ship movements. No army radio traffic was heard. Even these messages ceased on 9 April. Because of the great distance only a few Norwegian coastal stations were heard. Up to 8 April this traffic was normal, but on the night of 8 - 9 April it increased to a point of wild confusion. Normal army radio traffic was observed in Sweden. After the platoon's first move to Als on the Kattegat, Norwegian Army messages were also intercepted, as well as traffic between Swedish and Norwegian radio stations. It was not until 24 April, that is, eleven days after the operations had commenced, that the intercept platoon was moved up to Oslo and thus employed in the vicinity of

~~CONFIDENTIAL~~
Security Information

MS No. P-038 Chart 2

**RADIO INTELLIGENCE
DURING THE NORWEGIAN CAMPAIGN
31 MARCH-14 JUNE 1940**

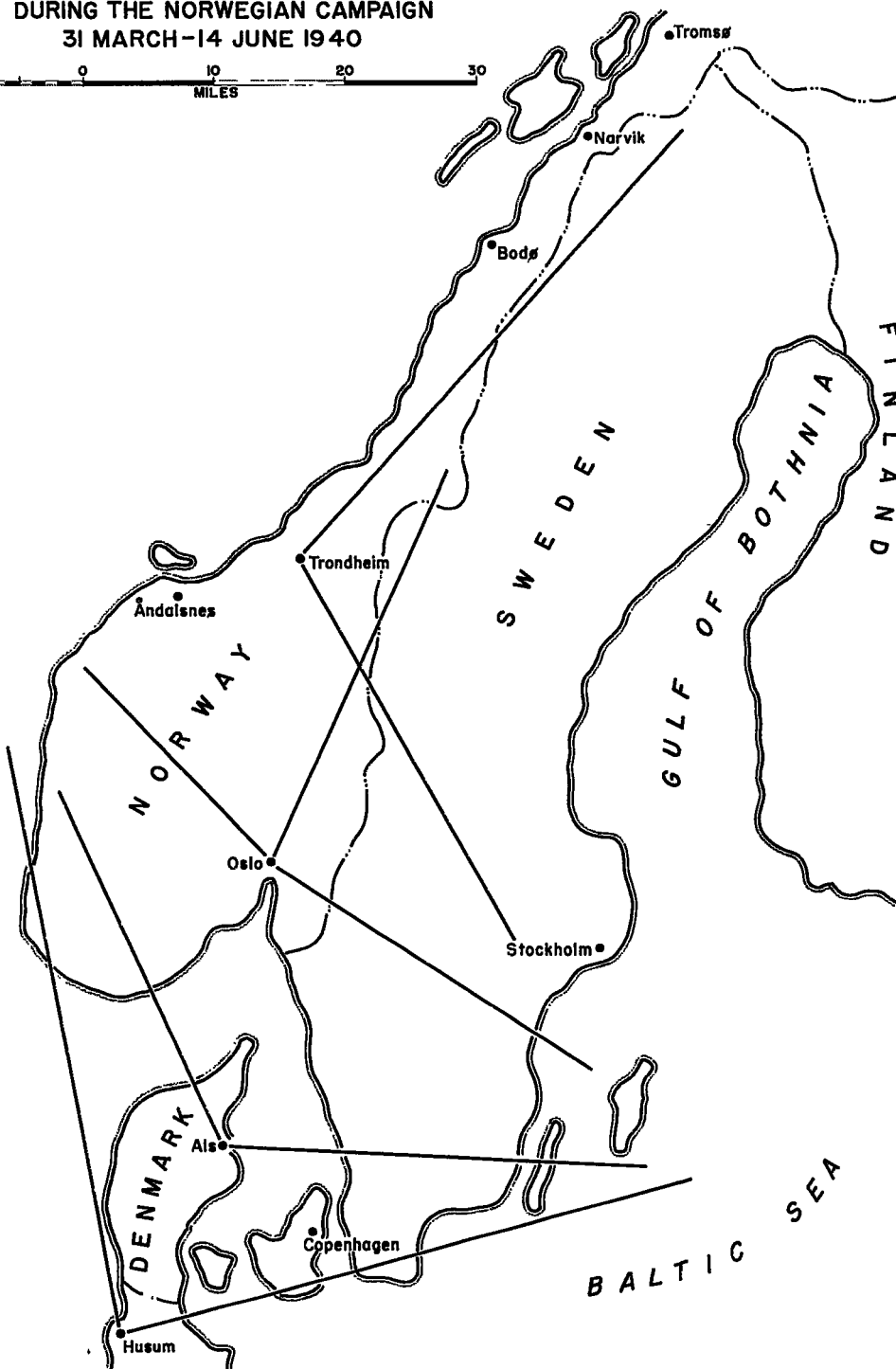

~~CONFIDENTIAL~~
Security Information

~~CONFIDENTIAL~~~~Security Information~~

MS # P-038

-16-

the German operations staff. (Chart 2)

The Norwegian Army stations usually transmitted in the clear. Radio stations in central and southern Norway were intercepted, but few of the messages were of any tactical value.

Radio messages between Great Britain and Norway were more important. The admiralty station transmitted encrypted orders to the naval officers in command of Harstadt, Andalsnes, and Alesund. Although these messages could not be solved, they provided clues to the most important debarkation ports of the British Expeditionary Force. In particular, they confirmed the landings near Harstadt, which had hitherto been merely a matter of conjecture.

The Germans intercepted the field messages of the British units which were advancing from the Andalsnes area by way of Dombas - Otta - Hamar to Lillehammer in the direction of Oslo. They used code names for their call signs and signatures. The messages themselves could not be solved. However, since the code names were learned after a short time from captured documents, the chain of command and composition of units were soon clearly recognized and the enemy's movements were followed.

Swedish radio stations were frequently heard transmitting to Norwegian stations. They handled mostly official and business messages. Norwegian radiograms were then often relayed from Sweden to Great Britain.

When, in the middle of May, a part of the German command staff was transferred to Trondheim the intercept platoon went along and found especially favorable receiving conditions near this city, which is approximately 1,500 feet above sea level. A large Norwegian radio net regularly

~~CONFIDENTIAL~~~~Security Information~~

~~CONFIDENTIAL~~~~Security Information~~

MS # P-038

-17-

transmitted air reconnaissance reports, information on the composition and commitment of the Norwegian 7th Division, and mobilization orders for the unoccupied part of Norway. They mentioned General Fleischer as commander in northern Norway.

Two radio stations continued to operate east of the island of Vega in the rear of the German 2d Mountain Division, which was advancing to relieve Narvik, until they were knocked out as the result of intercepts. The majority of the radio stations which were observed were in the Narvik area or north of it. The Alta ski battalion was often mentioned as being in action. Additional stations of other radio nets were identified in Kirkenes, Vardø, Harstadt, Tromsø, Alta and Honningsvåg. After the end of hostilities on 9 June all Norwegian radio traffic stopped within a few hours. Messages from British and French units were also picked up, as well as the traffic of the Polish mountain units. For the purpose of avoiding confusion with internal French traffic, a temporary teletype line to the commander of the German intercept troops in France was set up, so that any sky waves from France could be recognized and tuned out.

*

In order to furnish Kampfgruppe Dietl in Narvik with radio intelli-

* Tr: a term loosely assigned to improvised combat units of various sizes, named usually after their commanders/

gence of purely local importance without any loss of time, the intercept platoon was ordered to organize a short-range intelligence section, but as a result of the development of the situation this section never saw action. Instead, intercepts of interest to Kampfgruppe Dietl were forwarded to it through Sweden by telephone and teletype. During 7 and 8 June all non-

~~CONFIDENTIAL~~~~Security Information~~

~~CONFIDENTIAL~~
~~Security Information~~

MS # P-038

-18-

Norwegian radio traffic stopped. In this way the withdrawal of the Allies from Narvik was confirmed. This was also reported to Kampfgruppe Dietl.

The traffic between Great Britain and Norway, which had already been intercepted near Oslo, was now observed in larger volume from Trondheim. Most of the traffic was between Scotland (possibly Prestwick) and Bodø or Tromsø. The volume of messages was very large. The average word count was 200 letters. Every evening the Germans intercepted situation reports of the Norwegian High Command in Tromsø, orders from the Admiralty in London, mine warnings, SOS calls, government radiograms to England and France, personal messages from King Haakon to King George of England and Queen Wilhelmina of the Netherlands, and reports from the Reuter correspondents attached to Norwegian units.

On 25 May the radio station in Bodø was destroyed by German bombers. Scotland called Bodø for twelve hours in vain. Messages then transmitted by the Vadsø station were immediately intercepted. The Germans continued to intercept the traffic between Norway, Sweden and Great Britain.

Both the Trondheim station and the intercept platoon radioed a demand for surrender to the Norwegian High Command in Tromsø. After its acceptance these radio channels were kept in operation until the middle of June when the platoon was disbanded and its personnel returned to their former units on the Western Front.

British radio traffic was, as usual, well disciplined and offered few opportunities to German radio intelligence. For this reason the intercept platoon endeavored to work on as broad a scale as possible, to intercept a large number of messages, and to probe for soft spots. Since it

~~CONFIDENTIAL~~
~~Security Information~~

~~CONFIDENTIAL~~~~Security Information~~

MS # P-038

-19-

lacked special equipment and suitable personnel, the British ciphers could not be solved. Therefore, clear-text messages or code names and traffic analysis had to suffice as source material. The evaluation, therefore, was based chiefly on the procedural aspects of enemy radio operations.

Today it appears incomprehensible why the British seriously impaired the value of their well-disciplined radio organization and their excellent ciphers by transmitting call signs and signatures in the clear. Operating mistakes of this kind provided valuable information to the German intercept service, although it was poorly trained and insufficiently prepared. Subsequent experience on other battlefields showed that more extensive and intelligent efforts on the German side would have resulted in even more opportunities for breaking British ciphers.

British-Norwegian radio traffic was typical of the deficiencies which develop in a coalition with a weaker ally. It was carried on according to Norwegian standards and offered a wealth of information to German communication intelligence. The British and Norwegians were apparently unable to use a common cipher. On the other hand, the operating efficiency of their radio communication was high. The Norwegian personnel appeared to have been recruited from the ranks of professional radio operators.

At this point it should be repeated that the use of clear-text messages and code names should be avoided as a matter of principle. If code names were considered indispensable, they should have been frequently changed. A decisive transmission error prominent in traffic between the British Isles and Norway was the use of call signs in the clear as listed in the Bern Table of Call Signs. By this means alone it was possible to recognize and

~~CONFIDENTIAL~~~~Security Information~~

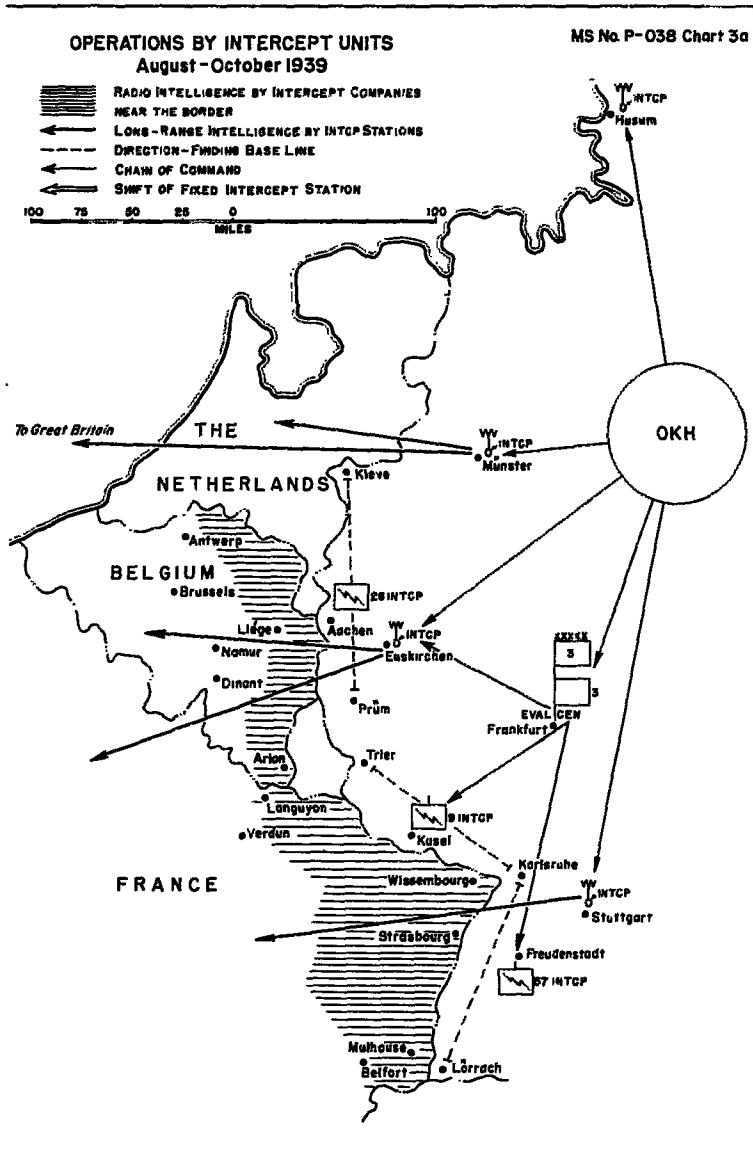
~~CONFIDENTIAL~~

October 1939 - January 1940

MS No. P-038 Chart 3b

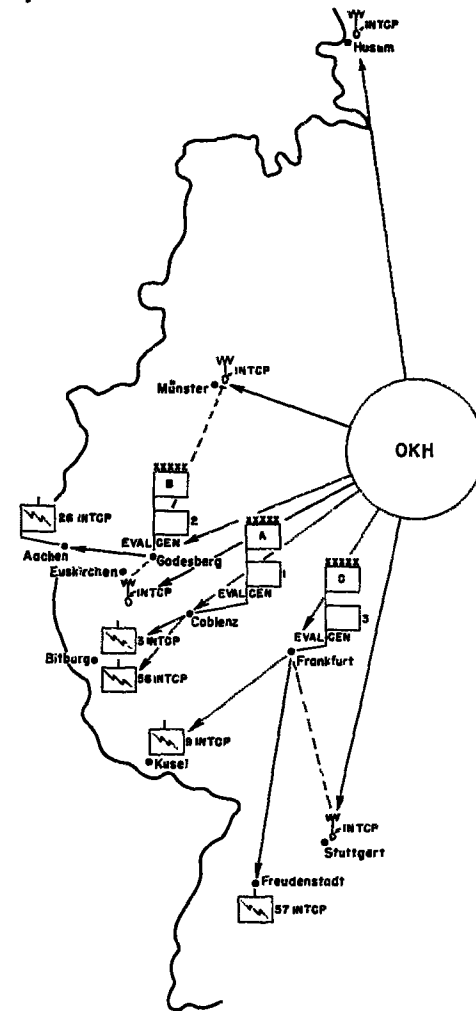
~~CONFIDENTIAL~~

~~CONFIDENTIAL~~

February-April 1940

MS No P-038 Chart 3c

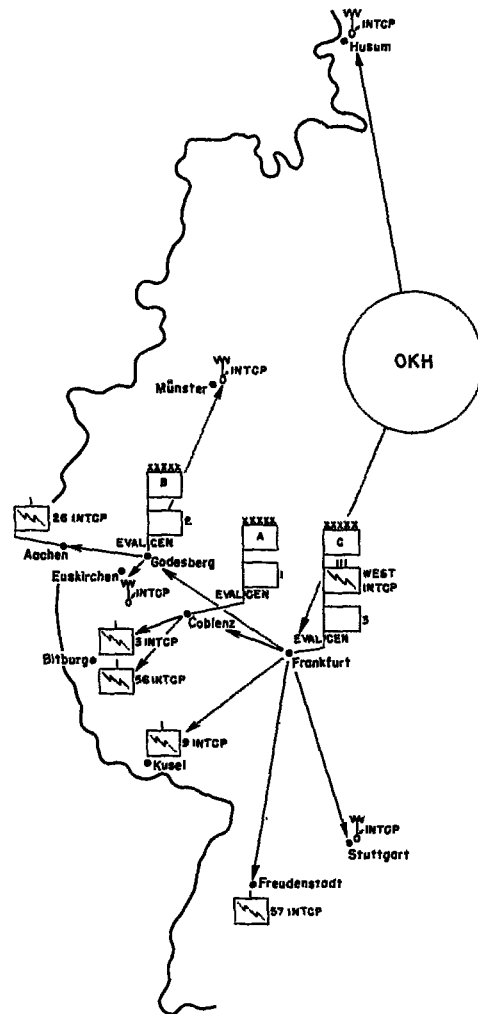

After April 1940

MS No P-038 Chart 3d

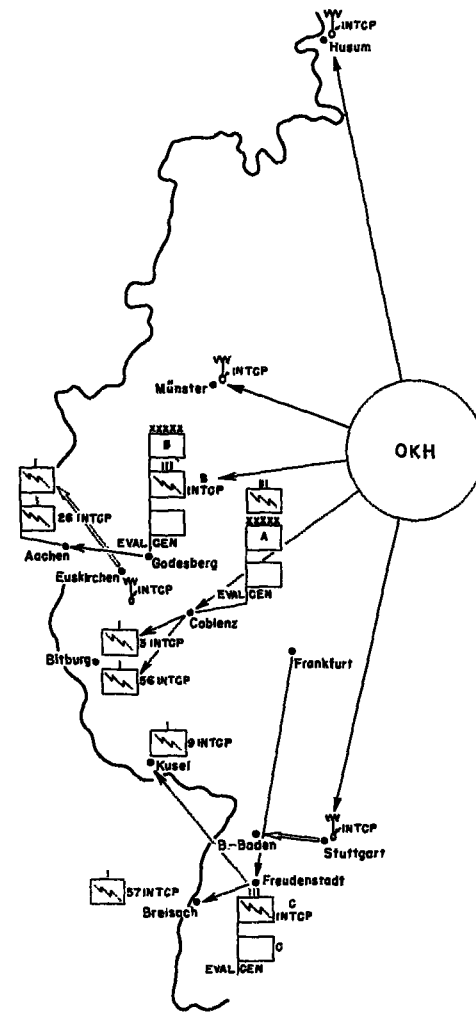
~~CONFIDENTIAL~~

~~CONFIDENTIAL~~
~~Security Information~~

MS # P-038

-20-

identify these messages after only a few minutes of listening.

Communications with an ally should be prepared with particular care and transmitted according to one's own radio system, and preferably with one's own personnel, in order to avoid all foreign characteristics.

By way of summary, it can be stated that during the Norwegian Campaign British radio operators did not at all times observe the security measures which would have protected them from interception and evaluation by German intelligence.

The over-all results achieved by German radio intelligence during this campaign were quite modest and understandably so, in view of the shortage of equipment and personnel, which consisted of only one first lieutenant and twenty-four enlisted men. This is no way a reflection upon the quality of their work, however.

VII. Campaign in the West (1940)

(This section was written by Colonel Randewig, at that time commander of the intercept troops attached to Army Group A.)

Prior to the beginning of the Western Campaign on 10 May 1940, the operations and command channel structure of German radio intelligence was divided into four chronological phases, as illustrated in Charts 3 a-d.

Up to January 1940 the fixed army intercept stations were under direct OKH jurisdiction with regard to long-range intelligence covering France, Belgium, the Netherlands, and Great Britain. Following instructions from OKH, Intercept Evaluation Center #3 -- operating with Army Group 3 Headquarters (in Frankfurt am Main), which was then responsible for operations in the West -- ordered the mobile intercept companies to intercept

~~CONFIDENTIAL~~
~~Security Information~~

~~CONFIDENTIAL~~
~~Security Information~~

MS # P-038

-21-

Belgian and French traffic emanating from the border region. The intercept companies which became available for re-assignment at the end of the Polish campaign were sent to the West.

For operations, therefore, the headquarters of intercept troops with each army group was assigned one evaluation center and two intercept companies (the fixed intercept station at Euskirchen had been temporarily motorized as an intercept company). The Muenster and Stuttgart fixed intercept stations continued to receive their orders directly from OKH, but were instructed to co-operate with the commanders of intercept troops (the Muenster station with Army Group B, and the Stuttgart station with Army Group C). It was intended to move them forward as soon as possible.

Prior to the start of major operations the information obtained by radio intelligence from the northern sector held by British and French forces was not particularly valuable because of the great distance involved -- for instance, 210 miles between Lille and Muenster -- and because of its largely technical character. Thus, all intercept units were thoroughly familiar with the French system as a result of the many field messages which had been copied. The intercept units of Army Group B were also familiar with the Belgian, Dutch, and British systems. As early as December 1939 the Germans broke a special cryptographic system used by the French command in radio messages to the armies and military district headquarters. It had been used contrary to regulations prior to the opening of hostilities in September 1939. The Germans were able to solve this system because the radio station guilty of the violation was reprimanded and thereupon repeated the same messages in the proper system. Their contents revealed a certain amount of organizational information, for example, the fact

~~CONFIDENTIAL~~
~~Security Information~~

~~CONFIDENTIAL~~
~~Security Information~~

MS # P-038

-22-

that the French 2d and 3d Cavalry Divisions had been reorganized into the 1st and 2d Armored Divisions and were due to move into their assembly area northeast of Paris by 1 January 1940. However, this type of incomplete information could generally be considered only as a supplement to and confirmation of other intelligence concerning the enemy. It was not possible to deduce the enemy's order of battle from radio intelligence alone.

Nevertheless, the Germans could identify the probable concentration areas of the French and British armies from the practice messages sent by the field radio stations, although the boundaries of army groups, armies, corps and divisions could not be established with any certainty. Greater clarity prevailed about the fortified area behind the Maginot Line in the south. Enemy forces stationed near the Franco-Swiss and Franco-Italian borders were not observed according to any regular plan. Spot-check intercepting failed to pick up the French Tenth Army in the place where it was presumed to be by the German command. However, radio intelligence did indicate the presence of the French Sixth Army.

Intercepted radio messages from the British Expeditionary Force enabled the Germans to conclude that the following units had been transferred to the Continent: one army headquarters under the command of General Lord Gort, three corps headquarters, five regular, partly motorized divisions (apparently the British 1st to 5th Divisions), one armored division, as well as several divisions of the second and third waves, the exact number and numerical designations of which could not be ascertained.

The intercepted Belgian and Dutch messages permitted only one conclusion, namely that their preparatory measures were directed against Germany exclusively. Belgian traffic was characterized by good radio discipline,

~~CONFIDENTIAL~~
~~Security Information~~

~~CONFIDENTIAL~~
~~Security Information~~

MS # P-038

-23-

whereas the Dutch were more careless.

The missions which OKH gave to the army group headquarters concerning radio intelligence were merely supplemented by the latter. Army Groups B and A were requested to give priority to intelligence pertaining to the British army as well as the French First and Seventh Armies. Special value was attached to ascertaining at an early date whether the French Seventh Army ("l'armée d'intervention en Belgique") would immediately march into Belgium.

At first the fixed intercept stations were ordered to cover the more remote areas beyond the French border. OKH was guided by the idea of retaining most of the long-range intelligence in its own hands, and of having the intercept companies concentrate more on short-range intelligence. To be sure, this intention was not clearly expressed in the orders. It also soon became evident that two fixed intercept stations did not suffice for long-range intelligence.

During the first few weeks the main efforts of radio intelligence were concentrated on the area facing Army Group B.

Immediately after the opening of hostilities Dutch and Belgian radio traffic increased suddenly in this area. From clear-text messages sent by the Dutch III Corps (near Hertogenbusch), which were supplemented by clear-text radio reports from the Dutch 2d and 4th Divisions (near Rhenen at the Grebbe Line), we learned on 11 May that the enemy had decided to withdraw into "Fortress Holland." We also learned from the Belgian traffic picture, which was supplemented by clear-text messages from the Belgian 6th Division (Beeringen), that the Belgians

~~CONFIDENTIAL~~
~~Security Information~~

~~CONFIDENTIAL~~
~~Security Information~~

MS # P-038

-24-

intended to offer strong resistance behind the Albert Canal.

On 10 and 11 May French radio traffic in the Poperinghe - Ypres - Courtrai area, and British traffic in the Ghent area, enabled us to realize that elements of the French Seventh Army and apparently also elements of the British Army had advanced into Belgian territory. Moreover, we were able to deduce from the transmitting characteristics that the British 1st Armored Division had moved from Brussels to Louvain. As early as 12 May a message from the headquarters station of the French Seventh Army was solved which indicated that the latter intended to defend the Dyle (River) positions. Direction finders revealed the landing of French units on Walcheren Island, which fact was confirmed a few days later in actual combat.

As the result of the surrender of the Dutch Army the interception of Dutch radio traffic could be discontinued as early as 15 May.

During the battle for the Dyle positions the Germans picked up the command nets of the French First and Seventh Armies (with headquarters plotted at Ypres and Valenciennes as of 17 May), although from the radio messages transmitted within these nets to the subordinate corps and divisions it was possible to determine only the total number and not the designation of these units. So far as the author can remember, only on a few occasions could such designations be picked up from messages carelessly radioed in the clear, as, for example, when the French 54th and 72d Divisions were detected on 19 May as belonging to the same corps in the Ghent - Bruges area.

It was equally impossible to ascertain the divisional designations

~~CONFIDENTIAL~~
~~Security Information~~

~~CONFIDENTIAL~~~~Security Information~~

MS # P-038

-25-

within the British army, the headquarters of which was found to be in Hazebrouck on 23 May. However, by the end of May the presence of twelve divisions had been traced, which included in addition to the regular divisions, the 1st London, 12th, 23d, 45th, 50th, and 51st Divisions.

No more Belgian command radio traffic was observed after 19 May, when the Franco-British forces in the north under General Billotte were threatened by a double envelopment in the Valenciennes - Cambrai - Maubeuge - Mons area. After 22 May the Germans were able to plot the withdrawal of French and Belgian units from the Ghent Canal and Schelde River westward from the line Bruges - Ghent - Tournai.

On that day the British army headquarters established direct radio contact with the Ministry of War in London, and the French army group commander exchanged a remarkably large number of messages with the French High Command. In spite of intensified efforts the Germans were unable to break the enemy cryptographic system.

Unusually long encrypted messages -- likewise unbreakable -- from French First Army headquarters to an unidentified higher staff located south of the Somme suggested that joint action for attempting breakouts was being agreed on by radio. These breakout attempts then actually took place near Valenciennes, Arras, and Cambrai. Clear-text messages sent on 24 May, in which complaints were voiced about the lack of ammunition, rations, and fuel, confirmed that the situation within the pocket was becoming critical. On 25 May a message to the British commander at Calais, with the order to defend the fortress and port with all available means, confirmed the seriousness of the situation. This same message enabled the Germans to locate the British 5th Division,

~~CONFIDENTIAL~~~~Security Information~~

~~CONFIDENTIAL~~
~~Security Information~~

MS # P-038

-26-

together with the French 68th Division, near Nieuport, and it also indicated the beginning of the evacuation of the British Expeditionary Force to England.

On 26 May intensive direction-finding operations confirmed the concentration of British, French, and Belgian forces in the area including Ghent, Courtrai, Valenciennes, Lens, Béthune, St. Omer, and Gravelines. Outside this area no more enemy traffic was heard.

After 28 May, approximately the time of the Belgian capitulation, it was no longer possible to distinguish the various radio nets and to observe and evaluate them systematically. Continued direction-finding operations indicated that the encirclement area had been split up into three pockets: a northern one, east of Dunkirk, from which mostly British traffic was heard; a central pocket, northwest of Roubaix; and a southern pocket, southeast of Lille. Because of the concentration of a great number of transmitters within one narrow area, it was no longer possible to take accurate bearings. The intermingling of different units was reflected by the confusion which was beginning to spread among the radio operators, who no longer felt bound by any rules, all of which resulted in a situation which in German radio terminology is described as a "call sign and wave-length stew."

An evaluation of the radio traffic during the first phase of the campaign in the West -- with the exception of the Dutch traffic, which practically disappeared after five days of fighting -- leads to the following conclusions: The different operating techniques made it easy to distinguish rapidly between French, British, and Belgian units.

~~CONFIDENTIAL~~
~~Security Information~~

~~CONFIDENTIAL~~
~~Security Information~~

MS # P-038

-27-

Generally speaking, the enemy transmitted too many messages and thus enabled the Germans to intercept them without any trouble. However, except for serious violations of radio security, such as the sending of messages in the clear, German intelligence was confronted with considerable difficulties, because the majority of the cryptographic systems proved unbreakable.

In view of the rapid conduct of operations, particularly those of motorized and armored units, the information obtained by German radio intelligence was of secondary importance in comparison with that gathered by ground and air combat reconnaissance, especially the close reconnaissance.

On the evening of the first day of the attack German radio intelligence picked up messages from the area west of Namur facing Army Group A. The characteristics of these messages left no doubt about the presence of at least two French armored divisions. The fact that this was reported in time, together with reliable information about the disposition of enemy forces on the western bank of the Maas, made it possible to warn the German armored units which had been moved forward to the Maas and which, after crossing the river on 15 May, were actually engaged in heavy fighting.

Remarkable radio discipline was observed by the French Ninth Army, which was soon to be attacked by Panzergruppe Kleist and by the inner

* Tr: armored force equal to an army in size and operating in conjunction with one/

flanks of Army Groups A and B between Maubeuge and Montmedy. The information obtained by the 56th Intercept Company, which was committed along the axis of advance of Panzergruppe Kleist, was therefore initially unim-

~~CONFIDENTIAL~~
~~Security Information~~

~~CONFIDENTIAL~~
~~Security Information~~

MS # P-038

-28-

portant. Since the 56th Intercept Company could not, in the long run, keep pace with Panzergruppe Kleist, while carrying on its direction-finding operations, it was ordered to halt on 20 May near Le Cateau, where it took bearings from two base lines: from the first, directed westward toward Maubeuge - Péronne, it searched the area bounded by the Franco-Belgian border on the right and by the Somme as far as the Channel coast on the left, while from the base line directed southward through Arras and Rethel it covered the Somme and Aisne sectors.

The 3d Intercept Company was assigned to the Laon - Arlon base line after it had crossed the Franco-Belgian border on 14 May. While the French moved up division after division in order to cover the open flank, which had developed along the Aisne and Somme as a result of the advance by Panzergruppe Kleist, these two intercept companies gradually succeeded in identifying the enemy groupings to the south.

As early as 14 May a new army net with three secondary stations was detected. An army headquarters was plotted as being west of Verdun, but on the basis of the first observations it could not be identified as that of the French Second Army. One corps was found east of Reims, near Grandpré, and in Dun-sur-Meuse, respectively. There was some doubt concerning the significance of the staff detected east of Reims; instead of corps traffic it might also have been the inter-net traffic of an army. In the final evaluation the results were treated cautiously, and it was merely concluded that the French Second Army sector had been widened, leaving open the possibility that a new front was being built up between Rethel and Stenay.

Two days later, on 16 May, a new headquarters near Epernay appeared

~~CONFIDENTIAL~~
~~Security Information~~

~~CONFIDENTIAL~~~~Security Information~~

MS # P-038

-29-

on the air with links to the corps in the Challerange - Grandpré area in the center of the above-mentioned net. On the basis of a clear-text message this headquarters was identified as the new Sixth Army under General Touchon, who was mentioned by name. This information, at first doubted by the German command, was confirmed by other sources on 20 May. On 22 May the western flank of the new Sixth Army was plotted south of Amiens. On the same day near Montdidier a mobile division was identified which had been brought up from the area north of Verdun and had established contact with the Sixth Army.

On 23 May it was possible to determine the boundary between the French Sixth and Second Armies at the Aisne Canal north of Vouziers.

In the meantime it was possible, solely by intercepting division headquarters stations, to count every French division in the newly-established Aisne sector and to report daily every change. However, only in one instance did the Germans succeed in establishing a divisional designation, namely that of the French 6th Colonial Division, in Machault, southwest of Vouziers, on 19 May.

Reinforced by the 26th Intercept Company, which Army Group B was able to release in the north, radio intelligence now began the systematic coverage of the Somme sector between the coast and Péronne. Here on 23 May a new staff was recognized in the "radio picture" near Elbeuf, south of Rouen, and another near Clermont. It was not initially possible to identify clearly these two staffs as higher headquarters. It was not until ten divisions between the coast and the Oise were identified as belonging to "Staff Clermont" that the commitment of another army was reported.

~~CONFIDENTIAL~~~~Security Information~~

~~CONFIDENTIAL~~
~~Security Information~~

MS # P-038

-30-

In the following days the French Sixth Army at Épernay, the "Staff Elbeuf" and "Army Headquarters Clermont" were in contact with a station near Meaux, which, because of its high efficiency and characteristic transmitting technique, was believed to be the station of an army group headquarters. It maintained no contact with Second Army at Verdun, but a fourth command net did appear whose called station could not be located. As reported by the commander of intercept troops attached to Army Group C, the French Fourth Army at Nancy was not heard after 23 May from the fortified areas. Its station was now associated with new traffic which appeared irregularly in the Châlons-sur-Marne area but which could not be assigned any definite part in the command radio picture.

Nevertheless, the picture of the order of battle was well rounded: Army Group Meaux, in command of the Sixth Army at Épernay, "Armée Clermont," and "Armée Elbeuf," had the mission of defending the Somme and Aisne. This mission was confirmed by the radio address given by Premier Reynaud on 28 May.

Between 1 and 4 June the information concerning the unit disposition between the Channel coast and the fortified areas, which had been obtained by radio intelligence, was confirmed from a source which the author can no longer remember and was supplemented by the information that the "Armée Elbeuf" (which had recently been plotted in La Feuillie, east of Rouen) was the Tenth Army under General Altmeyer, which had been brought up from the Italian border; that "Armée Clermont" (now fixed as being in Creil) was the newly-formed Seventh Army under General Frere; and that Army Group Meaux was presumably the staff of General Besson, who commanded the Tenth

~~CONFIDENTIAL~~
~~Security Information~~

~~CONFIDENTIAL~~~~Security Information~~

MS # P-038

-31-

and Eighth Armies on the southern flank.

Chart 4 contains the radio intercept results which had been obtained up to the time when German Army Groups B and A moved into position for their attack across the Somme and Aisne on 4 and 7 June.

For this operation Army Group B, which had left the Euskirchen Fixed Intercept Station in northern France to intercept United Kingdom traffic, was assigned the 56th Intercept Company of Army Group A, which had hitherto been stationed near Le Cateau. Army Group A, in turn, was assigned the 18th Intercept Company, the third to be released from the East. Thus, each army group again had two motorized intercept companies at its disposal: Army Group B having the 26th and 56th Intercept Companies; Army Group A, the 3rd and 18th Intercept Companies; and Army Group C, the 9th and 57th Intercept Companies.

On 5 June, when Army Group B crossed the Somme, radio messages were intercepted which indicated that the enemy was concerned about the impending German attack because insufficient progress had been made in completing the positions between Fismes and the Moselle. On the same day British traffic was heard for the last time on the Continent, and, as far as the author recalls, brigades of the 51st Division were identified. A clear-text intercept, according to which French troops that had escaped to England from the pocket of encircled forces in the north were to be returned to Cherbourg, was forwarded to the Luftwaffe, so that these French elements could be uncovered and attacked from the air.

On 16 June, the day following Army Group A's crossing of the Aisne, the main radio station of the Ministry of War (which also served the French

~~CONFIDENTIAL~~~~Security Information~~

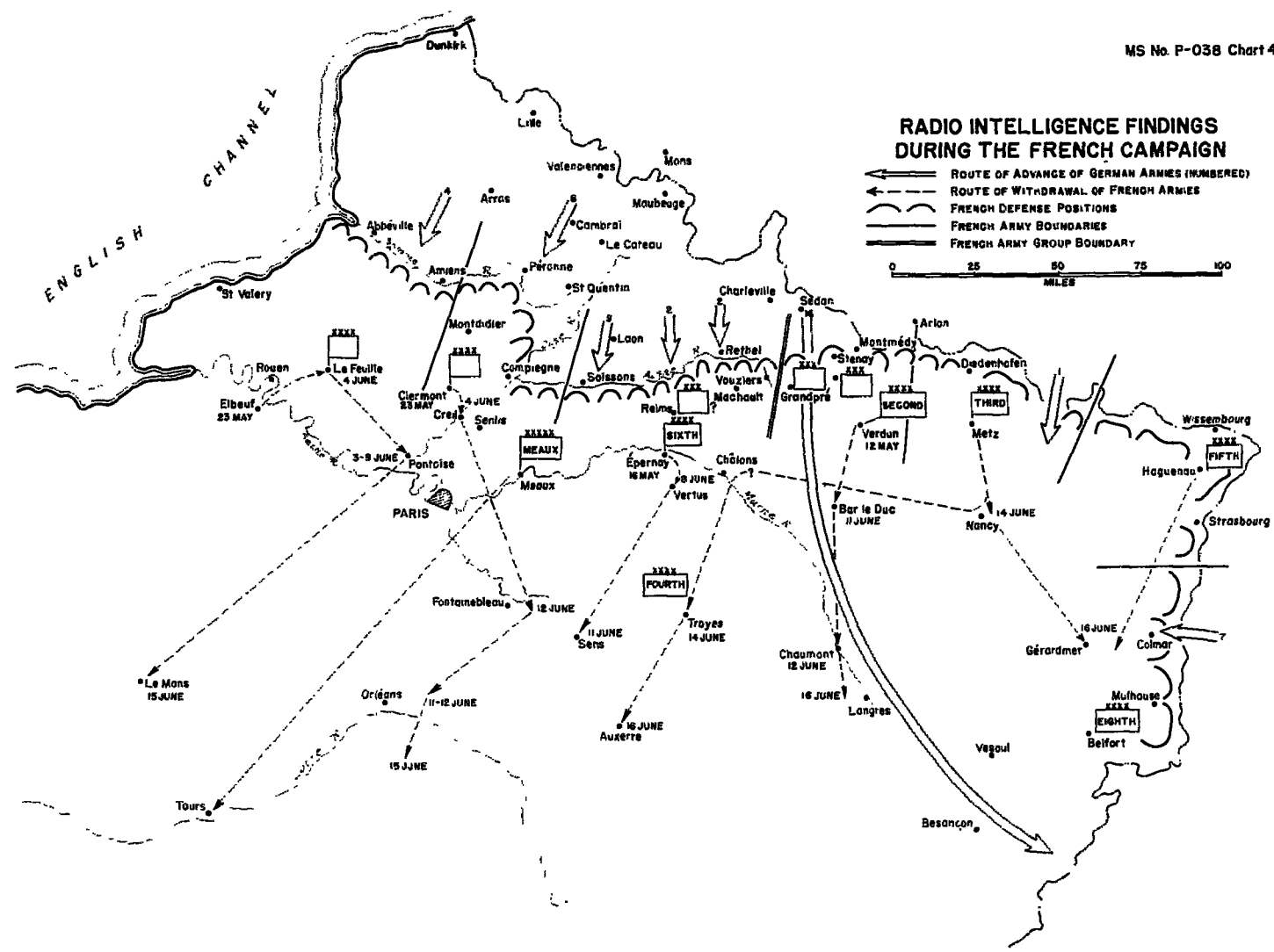

~~CONFIDENTIAL~~
~~Security Information~~

MS # P-038

-32-

High Command) closed down and turned over its functions to the main station at Tours, which was then assumed to be the new command post of General Weygand.

Enemy radio traffic from the area between the Oise and Marne had already stopped on 12 June. On that day, however, messages were intercepted from the French Fourth Army, which had long been sought in vain. The Germans continued to carry out direction-finding operations in the Châlons area, but no further details could be ascertained.

A radio message intercepted on 13 June revealed the decision of the French High Command to retreat behind the Loire.

On 15 June French radio traffic began to show signs of complete disorganization. Headquarters called each other in vain; blind messages became more frequent; the percentage of clear-text messages rose; various code designations were used, although it must have been realized that they were not secure. The confusion in radio operations pointed to the growing disintegration of the French forces. Radio intelligence of the pursuing German army groups had to restrict itself to following the movements of only the higher staffs, particularly the army headquarters. This information is shown in Chart 4.

In front of Army Group C the intercept service had kept the area behind the fortified front under surveillance since 10 May. Its mission was chiefly to find out whether, under the stress of the fighting in the north and center, units of the French Second, Third, Fourth, Fifth, and Eighth Armies were pulled out of their positions and moved to this part of the front.

~~CONFIDENTIAL~~
~~Security Information~~

About three days before the attack, in order to pin down the units along the fortified front, the Germans began to transmit fake messages in conjunction with other tactical deceptions in the area of the boundary between the German First and Seventh Armies. These measures simulated the traffic of an improvised army consisting of mobile units under the control of three corps headquarters. According to communications intercepted on 10 May from the area of the French Third and Fourth Armies, where the volume of traffic increased noticeably, the above-mentioned deceptive messages apparently caused concern. There were no indications of any weakening of the fortified front until this traffic was discontinued.

Not before 28 May was it clearly established that a mobile division of the French Second army had been moved out of position and transferred to the west. On the basis of its transmission characteristics, its movements could be followed as far as the Montdidier area. On the other hand, it was impossible to trace the location of the Fourth Army, which, on the following day, ceased to transmit from the fortified areas. Nor did the radio picture reveal that its sector had been taken over by the adjacent French Third and Fifth Armies. The withdrawal of the Sixth and Tenth Army Headquarters, which assumed command behind the lower Somme on 23 May, was not detected by radio interception, because the intelligence mission assigned to Army Group C had not included coverage of the Swiss and Italian borders. It has not been learned whether the fixed intercept stations under OKH, which were assigned exclusively to long-range intelligence, obtained any information.

When Army Group C commenced operations on the Saar front and crossed

~~CONFIDENTIAL~~~~Security Information~~

MS # P-038

-34-

the upper Rhine on 14 June, the intercept companies were given the mission of keeping track of those French units in the intermediate area which were capable of carrying out mobile operations. Along the fortified front the enemy on the whole observed excellent radio discipline, which continued until the German attack on the Rhine-Marne Canal ran into the Polish 1st and 2d Divisions. As a result of the advance of the army on the left of Army Group A (see Chart 4), the area covered by the three intercept companies was rapidly narrowed down, so that soon the same difficulties were encountered as during the observation of the northern pocket. Here, too, the results of radio intelligence were not as effective as those obtained by ground reconnaissance. Nevertheless, it was possible to detect in time -- that was approximately 15 June -- the assembly of French forces near Vesoul which led to the attempted break-through onto the Langres plateau.

As the encircled area became narrower, there appeared the same demoralization of the radio traffic as had been observed in the northern pockets and during the pursuit to the Loire.

After 20 June, when the French High Command requested an armistice, there was no longer any possibility of systematic radio intelligence in front of the three German army groups, because the enemy no longer possessed a well-defined command structure.

After the campaign in the West, captured documents, cipher devices and machines, and radio equipment of all types, confirmed and supplemented the picture, which the Germans had pieced together from the radio traffic of the British and French armies, and permitted them to make a fairly accurate evaluation of the security of the enemy systems. Except for their

~~CONFIDENTIAL~~~~Security Information~~

~~CONFIDENTIAL~~
~~Security Information~~

MS # P-038

-35-

effective cryptographic systems, the enemy had made no attempt to achieve adequate radio secrecy. Under these circumstances enemy messages did not have to be solved, since German radio intelligence could score valuable tactical and strategic successes by carefully observing transmission characteristics on those frequencies employed by the enemy and by plotting the location of his units.

German radio intelligence would have been denied these successes if the enemy stations had changed their frequencies, call signs, and operating signals at irregular intervals and if they had observed the cardinal rule of communication secrecy, namely, that one should use radio only in the following cases:

a. When wire communication cannot be used, for example, in communication with reconnaissance forces, including inter-unit communication within such forces; in communication with and within armored units; in communication with airborne units; and in air-ground communication.

b. When wire communication facilities have been destroyed and when the messages to be sent cannot under any circumstances be delayed until wire communication has been restored.

c. When wire communication functions too slowly to transmit urgent messages, such as alert orders or armored and air attack warnings.

d. In exceptional cases when wire facilities have been captured by the enemy -- a frequent occurrence during the Campaign in the West.

Enemy radio operations during the campaign gave the impression that these rules had not been taken seriously.

~~CONFIDENTIAL~~
~~Security Information~~

~~CONFIDENTIAL~~~~Security Information~~

MS # P-038

-36-

VIII. Intercept Operations against Great Britain 1940 - 41

(This section was written by Colonel Randewig, at that time commander of intercept units attached to Army Group A.)

After the conclusion of the Campaign in the West OKH ordered Army Group A to initiate radio intelligence operations against the British Isles.

This intelligence mission, which was given in the form of a preliminary order on 2 July 1940, was supplemented by mid-July with requests for the following specific information:

1. Present Location of former British Expeditionary Force units.
2. Organization, strength and disposition of Regular Army and Territorial Army forces in the British Isles, as well as of forces shipped to England from the Dominions, with special emphasis on Canadian troops.
3. Transfer of units from the mother country for service in the Near East (Balkans) and Middle East (Egypt and North Africa).
4. Defensive measures initiated by:
 - (a) Permanent coastal defense forces
 - (b) Mobile defense forces
5. Coverage of the coastal strip Folkestone - Hastings - Eastbourne - Brighton - Worthing and of the London - Chatham - Margate - Dover - Portsmouth - Reading - London area, these being the immediate objectives for a German invasion in accordance with plans for Operation SEELOEWI.

For carrying out this mission, the commander of intercept troops attached to Army Group A was placed in charge of the following units:

~~CONFIDENTIAL~~~~Security Information~~

1. The Muenster Fixed Intercept Station, hitherto at the disposal of OKH and recently moved from Muenster to The Hague after the capitulation of the Netherlands.
2. The Euskirchen Fixed Intercept Station (temporarily mobile), hitherto attached to Army Group B.
3. 26th Intercept Company, hitherto attached to Army Group B.
4. 56th Intercept Company, which during the first part of the campaign was attached to Army Group A, and, during the second part, to Army Group B.

OKH did not grant the request for the transfer of the Husum Fixed Intercept Station until late October 1940.

The fixed intercept stations were the only ones which had years of experience in observing routine British traffic. The experience of the intercept companies was limited to the relatively brief period when they had operated against the British Expeditionary Forces on the Continent during the blitzkrieg campaign. While the British forces were being assembled from September 1939 to May 1940, no noteworthy results were obtained. The use of intercept companies in peacetime to observe British maneuvers in the home country had been impossible because of the great distance (350 - 600 miles). The 56th Intercept Company had never intercepted British traffic at all.

The transfer of the Muenster station to The Hague determined the nature of its operations. Reception was extraordinarily improved by the reduction in distance to the target areas and by the fact that the intercepting was done exclusively over water. The results hitherto obtained

~~CONFIDENTIAL~~~~Security Information~~

MS # P-038

-38-

by the Muenster station had to serve as a basis for the operations of the three other intercept units.

Together with the "Muenster station" (now at The Hague) the following intercept units were assigned missions by 5 July 1940 as indicated:

(a) The Euskirchen station in Hardelot, south of Boulogne, was to search the long and medium wavelengths from the base line Ostend - St. Valery.

(b) 26th Intercept Company in Etretat, north of Le Havre, searched similar wavelengths from the base line St. Valery - Caen.

(c) 56th Intercept Company in Paramé, near St. Malo, searched the same bands from the base line Cherbourg - Brest.

The staff of the commander of intercept troops, together with an evaluation center, was located at Army Group A Headquarters at St. Germain-en-Laye near Paris. It was connected with its four (after 1 November 1940, five) subordinate units by direct wire lines.

After the middle of October the commander of intercept troops was assigned a mobile long-range D/F platoon for the interception of short-wave signals. After numerous unsuccessful trials, this platoon worked along several base lines, but without obtaining any important results.

The evaluation reports were sent daily to the OKH main intercept station, to the headquarters of Army Group A and its subordinate (Sixteenth, Ninth, and Sixth) Armies, to the military commanders of the Netherlands, Belgium - Northern France, and Paris, to the Luftflotte^{*} and to the naval

* Tr: Air force: a territorial and tactical command of the Luftwaffe⁷

~~CONFIDENTIAL~~~~Security Information~~

~~CONFIDENTIAL~~~~Security Information~~

MS # P-038

-39-

commander in Paris.

The operations of the intercept units, including the intercept areas, are shown in Chart 5.

In spite of intensive searching during the first four weeks (July 1940), it was impossible to intercept any messages of the kind which had been sent by mobile elements of the British Expeditionary Force on the Continent. To be sure, a few messages were picked up, but they could neither be followed for any length of time nor assigned to any regular net traffic, and frequently they were so brief as to preclude even the taking of accurate bearings. The few messages intercepted, though encrypted in a rather simple field cipher, were not enough for cryptanalysis purposes. In the final evaluation these observations were interpreted to mean that the seriously decimated divisions of the British Expeditionary Force first had to be reorganized, re-equipped and rehabilitated, and that in any event they were not yet ready for large-scale training exercises.

On the other hand, there was always regular traffic from fixed stations believed to be operating as "coast defense sector stations" (for example, in Chatham, the Portsmouth - Southampton area, Plymouth, Cardiff and Edinburgh) with a net control station near London. This traffic was easily intercepted because of the failure to change call signs and frequencies. Messages handled by this net provided material for the first attempts at cryptanalysis. However, there was hardly any chance to draw conclusions of a tactical nature from the traffic analysis of this coast defense net, since it was apparently operated by well-trained personnel who observed strict radio discipline. Of no importance were some clear-text intercepts,

~~CONFIDENTIAL~~~~Security Information~~

~~CONFIDENTIAL~~
Security Information

MS No. P-038 Chart 5

RADIO INTELLIGENCE OPERATIONS
AGAINST GREAT BRITAIN
JULY 1940 - JAN. 1941

← SHIFT OF FIXED STATION

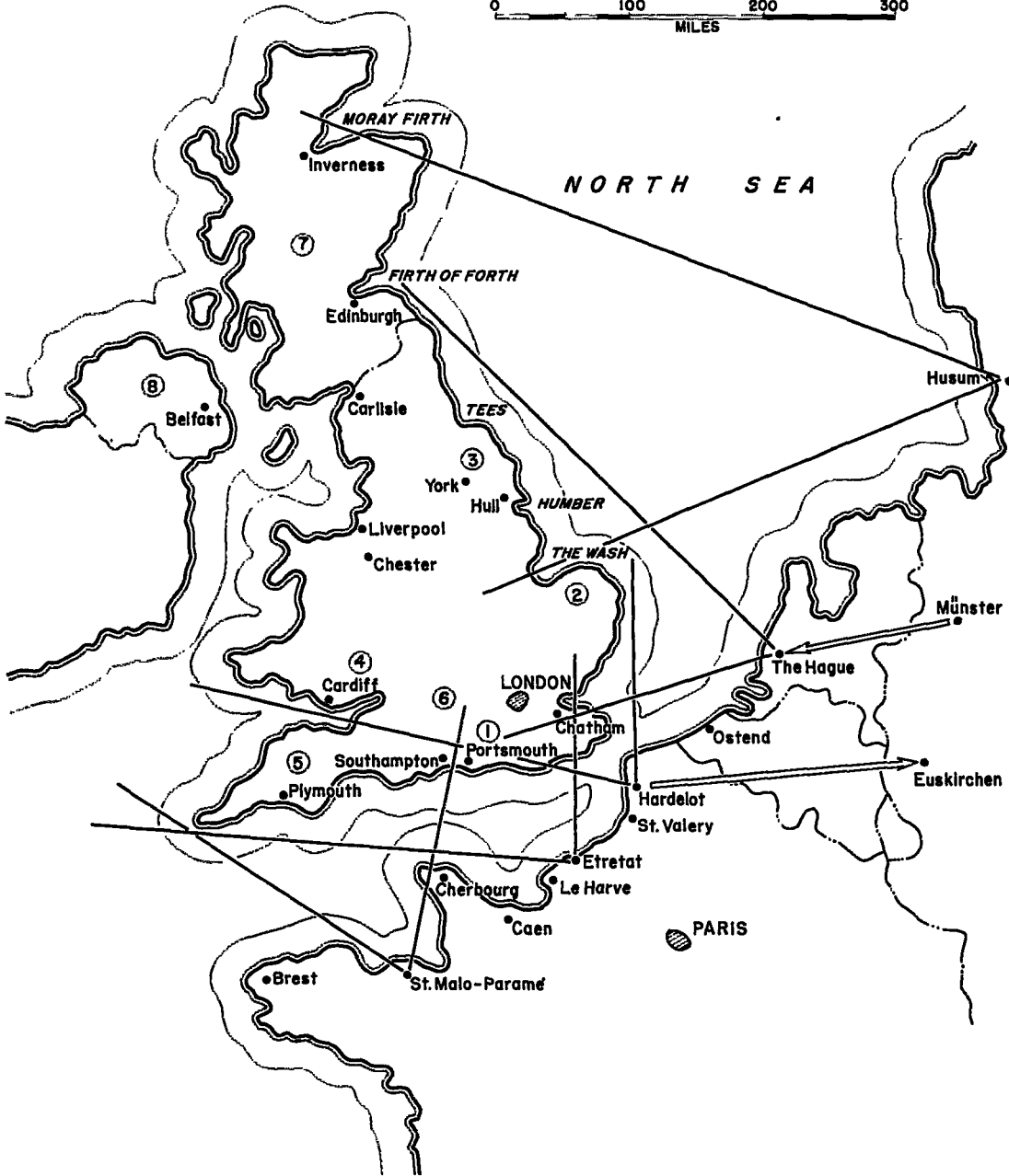

~~CONFIDENTIAL~~
Security Information

~~CONFIDENTIAL~~
~~Security Information~~

MS # P-038

-40-

such as: "Italy has the shape of a foot; with the other one Mussolini is standing in his grave." "Hitler says there are no more islands, but St. Helena is an island." "The abandonment of the Channel Islands was a mistake which could have been avoided."

After this initial period, which extended through August and September 1940, radio traffic emanating from mobile units increased in volume. By means of radio bearings four "training areas" (see Chart 5) could be plotted.

1. The Downs, including Sussex, Kent and Surrey;
2. Norfolk, with Wells-on-Sea, the first locality identified;
3. York, between the Humber and Tees; and
4. Monmouth, along the northern shore of the Bristol Channel.

In the beginning the training exercises in these areas were still characterized by the same excellent radio discipline which was observed by the fixed nets, such as, rapid tuning of transmitters preparatory to operation, brevity and speed of transmission, and avoidance of requests for repeat. In spite of the use of a single frequency for each net and the systematic use of call signs, inter-net relationships could only be guessed at; it was impossible to draw any conclusions from them regarding the organizational structure. No cryptographic errors were committed which could have led to the solution of their ciphers.

Transmission efficiency gradually diminished, probably because the training given the radio operators had been too short and inadequate. Names of localities appeared in the clear, and in the course of time abbreviations of unit designations were intercepted which were increasingly

~~CONFIDENTIAL~~
~~Security Information~~

~~CONFIDENTIAL~~~~Security Information~~

MS # P-038

-41-

easy to identify. Thus, it was possible to locate the Norfolk training area by the term "Wells-on-Sea brigade," and the unit to which this brigade was attached was clearly revealed by a repeat request in clear text. Subsequently, the new numerical designations of the two London divisions were identified in the same way. Unit designations were mentioned so frequently that it was finally possible to prepare a complete list of units of the British field armies, including Canadian forces, and the composition of divisions down to infantry and artillery battalions. At the same time the territorial headquarters, as well as the corps headquarters in command of the "Mobile Defense Forces," and thus the top-level organization, also became known. This information became available even before a single radio message could be solved. At first, the carelessness with which unit designations were revealed raised the suspicion that this was all part of a deliberate deception. The enemy would not have committed such serious violations of security rules unless his own monitoring system was a complete failure. The accuracy of German intelligence estimates was subsequently confirmed by the contents of other messages.

As a result of the information gathered about the composition of enemy forces, the Germans increased their regular intercept coverage of the training areas, especially those in southern England, with an eye to their intended landing operations. The constantly increasing radio traffic now also permitted analysis of the nets' structure and plotting of headquarters areas by the direction-finding units. In this manner it was possible to trace the concentration areas of the divisions assigned to the coastal defense and to follow the course of several anti-invasion exercises.

~~CONFIDENTIAL~~~~Security Information~~

~~CONFIDENTIAL~~~~Security Information~~

MS # P-038

-42-

During these exercises it was always possible to determine the command nets and sometimes the link with the RAF, while unit nets could rarely and armored traffic never be picked up at all. In several instances it was possible to distinguish between tactical (lower echelon) and command traffic. By combining the two, the purpose of the training exercises could be inferred. It was learned that in case of a German landing the coastal defense forces were to withdraw at first and then destroy the invader by means of mobile tactics after reassembling and forming centers of gravity.

In the course of time the following regions were added to the concentration and training areas of the "Mobile Defense Forces":

5. South Wales;
6. The Midlands; and
7. Scotland (on both sides of the Firth of Forth).

During intercept operations a few of the identified divisions disappeared from the radio picture for varying periods of time, some altogether. Their whereabouts in the interim could not be ascertained in most cases. In no instance was it possible to obtain reliable information about their movement overseas, which, however, was subsequently presumed to have taken place. A coincidence led to the discovery of a troop movement from Carlisle in northern England to Belfast in northern Ireland, which the Luftwaffe was ordered to reconnoiter and attack. The Germans made the mistake of neglecting to observe overseas radio communication with adequate means at the same time they were intercepting traffic between points within the United Kingdom.

~~CONFIDENTIAL~~~~Security Information~~

~~CONFIDENTIAL~~~~Security Information~~

MS # P-038

-43-

Nevertheless, the over-all picture of the disposition of the enemy forces continued to be known, especially since many of the cryptographic systems in use were broken after about September 1940.

In the beginning of 1941 the radio situation in the British Isles was so well known that five intelligence units were no longer necessary for regular interception, especially after the abandonment of Operation SEELOEWE for which some elements of the intercept companies had been intended.

After one intercept platoon had been transferred to the German Africa Corps, the 56th Intercept Company was given the same assignment in March 1941. About the same time, the "Euskirchen station" was returned from Hardelot to its peacetime location in Euskirchen. Experiments had indicated that the reception of sky waves from British short-wave transmitters was immeasurably better in Euskirchen than on the coast. In April 1941 the 26th Intercept Company was transferred to eastern Europe. The subsequent coverage of the British area was taken over by the fixed stations in Muenster, The Hague, Husum, and Euskirchen. A long-range direction-finding organization for long, medium, and short wavelengths was retained under the direction of the commander of intercept units of Army Group D, which had just assumed command in France.

Summing up, British army radio traffic in 1940-41 can be appraised as follows:

The messages could be easily intercepted for three reasons: each net operated on a single frequency, frequencies were changed only at regular intervals, and the British used a call sign system which facilitated the

~~CONFIDENTIAL~~~~Security Information~~

~~CONFIDENTIAL~~
~~Security Information~~

MS # P-038

-44-

identification of the NCS and secondary stations. Nor were these defects offset by the excellent radio discipline which the British observed in the beginning. When the latter deteriorated, even the most skillful encipherment could no longer guarantee security. Secrecy was lost by the mention of towns, areas, and troop designations in the clear. The careless way in which radio operations were carried out suggests that the British underestimated German communication intelligence.

IX. Intercept Operations Against Great Britain and the United States 1942

No substantial changes were made in the British radio system until the summer of 1942. The Bergen Fixed Intercept Station in Norway was established and it covered Great Britain, Canada, the United States, and the American bases in Iceland, Greenland, and Central America. Altogether, these areas were covered by about 150 receivers. British nets could be easily detected because they continued to use call signs taken from the "call sign families," for example, fba, fbae, fbb, etc. Moreover, clear-text messages transmitted both by phone and CW provided many valuable hints about the morale of the troops. Grid co-ordinates were easily solved, even if the fliers did not make the mistake, as was frequently the case, of radioing place names and grid co-ordinates in the clear, after which the ground station would immediately relay the very same designations in code.

The Canadians had to a large extent adopted the British procedures (call signs, frequencies, and cryptosystems) but they were distinguished by characteristic details, so that they could be identified even before cryptanalysis was instituted. The presence of the other Empire troops in

~~CONFIDENTIAL~~
~~Security Information~~

~~CONFIDENTIAL~~
~~Security Information~~

NS # P-038

-45-

the British Isles was detected by recognition of their individual characteristics. Still more revealing were the messages sent by foreign units stationed in England: the Poles, Belgians, French, Norwegians, and others.

Until its integration into the Regular Army, the traffic of the British Home Guard showed special characteristics which made it easy to observe its activities, organization, strength, and deployment. Valuable intelligence was obtained, either through the mention of individual troop units or of tactical doctrine, by observing RAF units which were attached to the Army. Such intelligence covered a variety of subjects, including individual aircraft, liaison staffs, and airfields. It enabled the Germans, for example, to follow every detail of an engagement during maneuvers, including the identification of tactical objectives as provided by British reconnaissance planes, the operations of major formations, and reports sent upon completion of a bombing mission -- all from the interception of clear-text messages.

Maneuvers in general were a fertile source of information, because the procedure signs (in the clear) which headed each message could be recognized immediately. Command post exercises provided an abundance of information about unit designations, physical location, organization, equipment, state of training, officers' names, in short, all the small pieces needed by intelligence for building up a complete jig-saw picture of the situation. Warnings exchanged between operators about impending inspections by their superiors showed that there was a lack of radio supervision.

~~CONFIDENTIAL~~
~~Security Information~~

~~CONFIDENTIAL~~
~~Security Information~~

MS # P-038

-46-

In the spring of 1942 a large-scale maneuver was carried out south of London, called "Operation Tiger," which lasted several days. Two motorized divisions and several RAF units participated, and their composition and strength were clearly recognized in a short time. The course of the exercises could be followed so exactly that, by sending over the Luftwaffe, the Germans could have converted the maneuver into a real combat action. These German intercept successes were shortly afterward confirmed by British press and radio reports.

The preceding description of British army traffic applies also to the Canadians during the same period. Although the distance to Canada was too great for perfect reception, it was nevertheless possible to follow newly activated units, the progress of their training, the overseas shipment of various divisions and their subsequent movements in the British Isles.

Until the summer of 1942 no difficulties were encountered in intercepting American radio communication, with the result that inter-net relationships could be clearly ascertained. From the more distant areas of the United States only the sky waves were heard, while troop exercises could not be picked up at all. Even after the subsequent co-ordination of British and American operation procedures there were still many characteristics which made it easy to distinguish the units of each Army. They used different operating signals and different abbreviations for identical service branches and units. In phone communication differences in enunciation provided the most striking contrast. Translators did not find it difficult to master both "English" and "American" literary, colloquial,

~~CONFIDENTIAL~~
~~Security Information~~

~~CONFIDENTIAL~~~~Security Information~~

MS # P-038

-47-

and military styles, as well as slang expressions. Special dictionaries and glossaries of idiomatic phrases were supplemented from current intercepts.

In the United States proper the activation of divisions and other units could be followed almost perfectly. Their stage of training could be ascertained from transfers to various camps. Their degrees of combat readiness and their impending shipment overseas became evident from the assignment of APO numbers. These APO numbers were then carefully followed. If they appeared in connection with an eastern port, for example, New York, it was clear that the unit concerned was to be shipped to Europe, whereas western port designations, for example, San Francisco, meant shipment to the Pacific.

American units were recognized soon after their arrival in the British Isles by the previously known APO numbers, and their subsequent whereabouts could be traced from clues similar to those provided by the British units. Thus, all major American units were currently identified.

A special source exploited by German communication intelligence was the transmission of officers' promotion notices. The typical message (in clear text) began as follows: "The President intends to promote you to ... Do you accept?" These "promotion messages" supplemented our locator files and enabled us to draw various inferences. If the unit of the officer in question had been previously known but its present station had not been traced, a promotion message transmitted, for instance, to Iceland would thus provide the Germans with its location.

In the spring of 1942 a new transmitting technique was introduced in

~~CONFIDENTIAL~~~~Security Information~~

~~CONFIDENTIAL~~
~~Security Information~~

MS # P-038

-48-

American long-distance communication (both domestic and foreign) that dried up this excellent source of German intelligence. The Buskirchen station, which was charged with cryptanalysis of this traffic, solved the riddle within one week, however, by means of tape recordings and systematic analysis. It was finally discovered that the process used was a rapid system of wireless telegraphy which differed from the usual method by the number of current impulses. This was the "Radiotype"

*
/Tr: Referred to as "War-type" in the original. "Radiotype" is a six-impulse teletype system developed by International Business Machines and used temporarily by the U.S. Armed Forces. /

method. A tremendous number of military and business messages were soon intercepted. After a short while the receiving operators were able to "read" the message tapes as fast as Morse code. Fortunately, after a pause of one week, military messages in clear text became more frequent for a time. This mistake was not discovered by the Americans until later, at which time they began to encipher these mechanically transmitted messages. Since it was no longer possible to solve them, work on these messages was discontinued.

German experience with these mechanically transmitted messages was the same everywhere, especially in the case of the Army Ordnance Office. The transmitting techniques could be mastered easily, unless the messages were encrypted in a reliable, preferably mechanical, cipher.

In the summer of 1942 the British introduced new radio techniques, which were also widely adopted by the Americans. At El Alamein the British captured the entire equipment of the intercept company attached

~~CONFIDENTIAL~~
~~Security Information~~

~~CONFIDENTIAL~~
~~Security Information~~

MS # P-038

-49-

to the German Africa Corps. As will be explained at length in the section on Africa, they recognized their former mistakes and quickly corrected them on all fronts. However, these new methods were not introduced everywhere simultaneously, but at first only in Africa. German intercept troops in western Europe were thus able to adjust themselves in time. German communication intelligence now encountered considerably more difficulties in evaluating the traffic. Call signs and frequencies were changed at irregular intervals, which made it impossible to recognize inter-net relationships. It required some time and considerable experimentation before other distinguishing characteristics enabled German traffic analysis and direction-finding units to overcome these difficulties. The numerous, informative messages in clear text disappeared. One of the best sources of intelligence were the careless transmissions of the RAF, over whose radio discipline the British Army apparently did not exercise any control or supervision.

The landing operation at Dieppe in August 1942 provided not only the Allies but also German communication intelligence with some interesting lessons, successes, and failures.

The preparations for this operation were completely concealed from German radio intelligence. The participating Allied units observed exemplary radio silence up to the actual landing. This procedure was the correct one and later resulted in the same degree of surprise during the landings in North Africa and during the invasion of Normandy.

Even after the landing at Dieppe, with its ensuing radio traffic, German radio intelligence did not immediately recognize what was going on.

~~CONFIDENTIAL~~
~~Security Information~~

~~CONFIDENTIAL~~~~Security Information~~

MS # P-038

-50-

The first intercepts were received with good signal strength by The Hague Fixed Intercept Station. Somewhat later the station in Etretat heard some extremely weak signals which failed to reveal the general situation. The Hague station had no data regarding their precise direction but, because of the strength of the signals, believed that fighting was going on in the Netherlands. With this in mind, it inquired at the local army headquarters, where nothing was known. OB West had not been notified. The report was transmitted very inefficiently from the attacked units through the long chain of command to OB West. By the time that the nature and location of the event had been clarified in this irregular manner, German communication intelligence was once again working systematically. The interception of all messages from Dieppe was centrally controlled from St. Germain. Enemy messages became more numerous and informative until around noon, then remained at the same level for a while, only to become fewer with the disengagement which took place in the late afternoon, and then disappeared entirely during the cross-Channel evacuation. OB West could be informed more rapidly about every phase of the fighting through radio intelligence than through the communication channels of the field units. Encrypted messages were solved even during the course of the attack. However, the numerous code names for targets, terrain features, and the like, could not be interpreted during the brief course of the operation. Conspicuous in these codes was the frequent mention of colors. Captured documents subsequently revealed that these indicated beachhead sectors. Since this procedure was repeated during later landings, any mention of colors came to mean to German communication intelligence:

~~CONFIDENTIAL~~~~Security Information~~

"Imminent danger of invasion." When the term "withdrawal" was openly mentioned at Dieppe at the beginning of the disengagement, it became clear that this was not an attempt at invasion but that it was an operation with limited objectives with respect to time and space.

The fact that German propaganda put the venture in a different light is immaterial. When the Propaganda Ministry finally asked for the numerous messages containing requests for help in order to use them in the press and on the radio, all the cryptanalyzed messages were omitted and texts in the clear were paraphrased to prevent the enemy from gaining any clues as to our intelligence results. Thus, German intercept operations were bound to appear far less effective than they actually had been.

X. Africa and the Near East (1941 - 43)

In March 1941 the German Africa Corps was given one intercept platoon, which was soon enlarged into an intercept company to which were assigned English-language cryptanalysts from the intercept command station. The company was equipped with receivers and direction-finding instruments suitable for use in a tropical climate. The personnel had had experience in intercepting British traffic ever since the Campaign in the West and therefore knew the weaknesses of the British radio system. During operations against the United Kingdom the Germans arrived at the conclusion that the British were underestimating the successes of German communication intelligence, and this became even more obvious in Africa. Here, in mobile desert warfare, radio was the only possible form of communication -- a medium as dangerous as it was valuable -- and the British used it more

~~CONFIDENTIAL~~~~Security Information~~

MS # P-038

-52-

carelessly than ever. A clear and accurate picture of the opposing British Eighth Army with regard to all the details of its composition, the origin of its divisions (South Africa, India, and so forth), and its morale and plans, was rapidly gained as the result of the mistakes described in the preceding section. These mistakes included clear-text radiotelephone and telegraph messages mentioning geographical data, the names of individuals, unit designations; the failure to mask such terms properly; and the use of extremely simple ciphers and routine call signs. The information which the intercept company of the Africa Corps gathered was mainly of the short-range intelligence type, supplemented by long-range intelligence carried out by the Commander of Communication Intelligence (Four) in the Balkans, who operated against British forces in the Near East. German intelligence in Africa also had some exceptionally lucky breaks, as, for example, when it was able to report on impending British operations after solving messages sent by the American liaison officer.

In the summer of 1942 a German submarine operating in the eastern Mediterranean captured a ship on which was found a complete set of radio codes used jointly by services of the British armed forces in the Mediterranean theater from Gibraltar to Egypt. The security of radio communication in this area was a matter of vital concern in safeguarding the British supply line. The submarine, which had been assigned to other tasks, was immediately recalled after reporting this valuable prize. Because it was then possible to decrypt rapidly all British radio communications using these codes, German countermeasures at sea and in the air were especially successful for the next two weeks. Then this traffic ceased

~~CONFIDENTIAL~~~~Security Information~~

~~CONFIDENTIAL~~
~~Security Information~~

MS # P-038

-53-

entirely. The British had become suspicious and did not resume radio operations until six weeks later, after couriers had been able to deliver new codes throughout this far-flung theater of operations.

The excellent results obtained by communication intelligence provided Field Marshal Rommel with accurate and welcome information, on which he could base his bold and varied tactics. His peculiar talent for gaining unexpected success in armored warfare, where radio communication played a vital role, had already brought him a number of startling victories as commander of a panzer division in the Campaign in the West. In the desert Rommel encouraged this new method of tactical reconnaissance, especially since the results of German air reconnaissance were limited by British air superiority. To facilitate the detailed evaluation of information by the intercept company, Rommel's chief of staff always had two field trunk circuits at his disposal to handle incoming telephone and teletype traffic. During all his inspection trips to the front Rommel was personally informed by radio about all important results obtained by radio intelligence. It may be assumed that the British did not employ any radio intelligence of their own against the German Africa Corps; at least they did not succeed in solving Rommel's codes. Thus, German radio intelligence was able to work unsuspected by the British.

By means of these modern techniques Rommel was able to carry on a masterly kind of desert warfare as long as enemy superiority was not overwhelming. Just as the ameers of the Caliph had once led their swift cavalry armies by personal example and trumpet signals, so Rommel now led to victory the "light cavalry" of his armored reconnaissance troops and

~~CONFIDENTIAL~~
~~Security Information~~

~~CONFIDENTIAL~~~~Security Information~~

MS # P-038

-54-

the "heavy cavalry" of his tanks. In this theater Rommel also made use of radio deception by having several radio stations simulate large forces far to the south in the desert and suggest an encirclement. On repeated occasions radio intelligence was able to observe that the British were taken in by this strategem, and that apparently without any confirmation by their reconnaissance planes they sent tanks and motorized artillery, once even an armored division, to oppose the fictitious enemy. On one other occasion, however, German radio intelligence was unable to detect a British armored division which had advanced far to the south, since it had observed absolute radio silence for several weeks, as was subsequently confirmed by a captured regimental commander.

One interesting observation by this company was the interception of appeals for assistance and water sent by radio to the British Eighth Army by the German Communist Battalion commanded by Ludwig Renn in the desert fort of Bir Hacheim, south of Tobruk.

In front of El Alamein the intercept company was able to report the reinforcement of the British forces and their preparations for an attack with which the German-Italian forces could not possibly cope. The intercept company and its evaluation center were imprudently stationed far in advance of Rommel's headquarters and only a few kilometers behind an Italian sector of the front which was subsequently penetrated by British tanks in late October 1942. While defending itself the company lost more than a hundred dead; the company commander was seriously wounded and died in a Cairo military hospital. Because of the surprise achieved by the tank attack, there was no opportunity to destroy the valuable intercept

~~CONFIDENTIAL~~~~Security Information~~

~~CONFIDENTIAL~~~~Security Information~~

MS # P-038

-55-

files. Thus, the enemy captured the German records of intercepted British messages and codes, the analyses prepared by the German intercept service, as well as German and Italian radio schedules and ciphers.

Radio Cairo reported: "The distinguished Captain Seeborn has been seriously wounded and is a prisoner of war. We are much obliged for the extensive amount of excellent materiel we have captured." The British reaction to the capture of the German intercept receivers has been mentioned elsewhere. In a very short time the British corrected their numerous, costly mistakes, after they had become fully aware of their damaging effects. This applied not only to the African theater, where the German command lost its reliable sources of intelligence, but also to all future British and American operations in North Africa, Italy, and France. Other sections of this study describe how German communication intelligence was for the most part capable of overcoming even these difficulties after a period of experimentation, during which results diminished, and how, in the heat of combat or when opposed by less disciplined units, the enemy repeated the same mistakes over and over again.

The successes of the German radio intelligence units under Rommel before El Alamein might well be considered as products of short-range intelligence. The main efforts of German long-range intelligence as well were directed toward the east, where momentous events appeared to be imminent. The German forces in Egypt were dangerously close to the Suez Canal. The southernmost German elements in Russia stood in the northern Caucasus and were advancing southward. Coverage of the situation in Egypt, Palestine, Transjordan, Syria, Iraq, and neutral Turkey, therefore,

~~CONFIDENTIAL~~~~Security Information~~

MS No. P-038 Chart 6

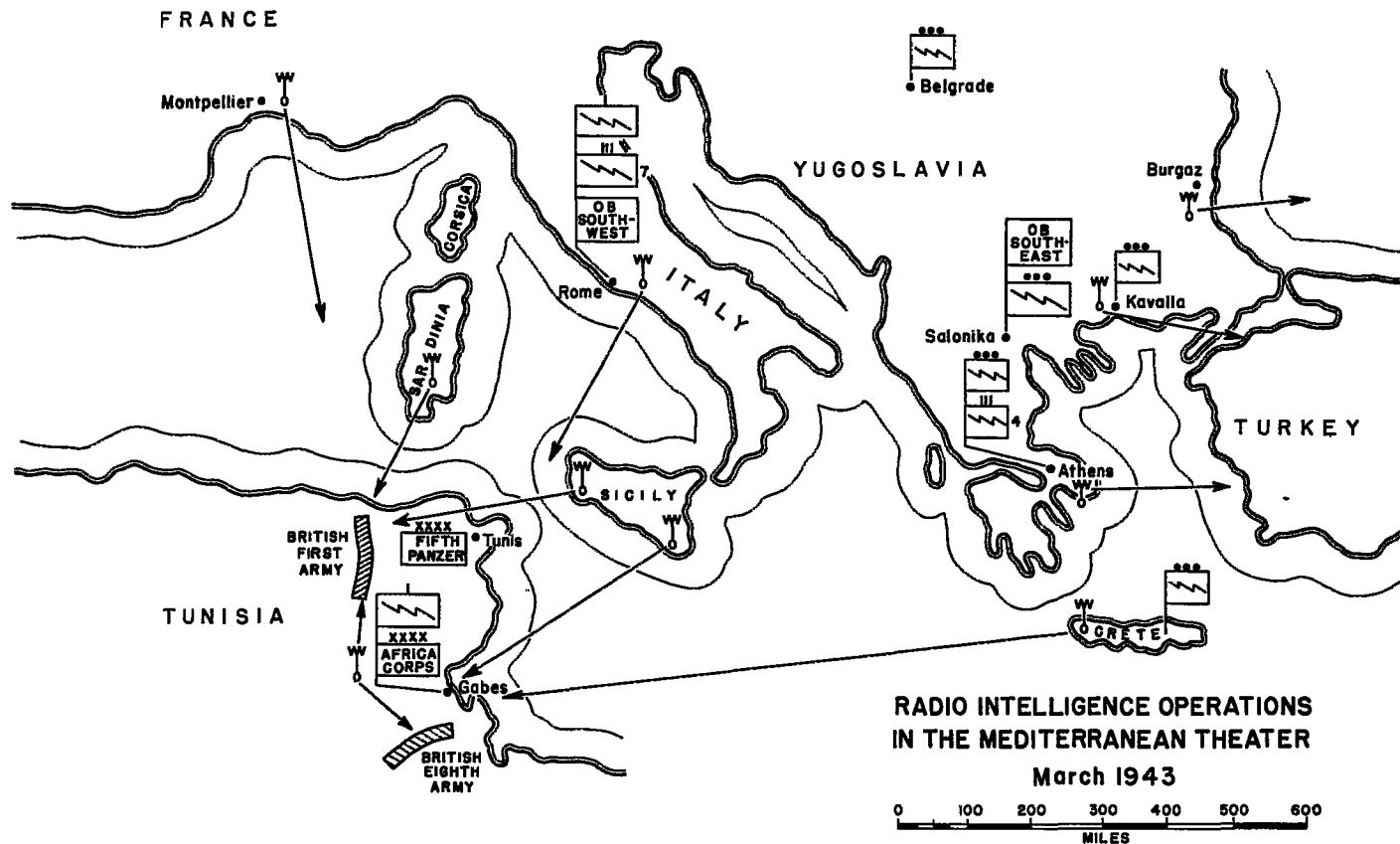

Note: The abbreviation "intcp" may hereafter be assumed to appear beside signal unit symbols.

~~CONFIDENTIAL~~
Security Information

~~CONFIDENTIAL~~
~~Security Information~~

MS # P-038

-56-

appeared of prime importance to the Germans. The possibility of an Allied landing on the western or northwestern coast of Africa was virtually disregarded. Only the Dakar area seemed to be of interest, inasmuch as an unusual amount of American radio traffic was observed there, as will be mentioned elsewhere.

In addition to the intercept company assigned to the Panzer Army of Africa^{*}, the intercept units mentioned in the section on the Balkan Campaigns

*

Tr: Formed in June 1941 as Panzergruppe Afrika to control the Panzerkorps Afrika (Africa Corps) and Italian units. Became a Panzer Army at the close of 1941. Entered Tunisia in the winter of 1942-43 and was destroyed there the following May.7

covered the above-mentioned areas from stations extending from El Alamein, to Crete, Athens, Salonika, Kavalla, and Burgaz. These units operated under the Commander of Communication Intelligence (Four) in Athens, who was subordinate first to OB Suedost (Southeast) in Salonika, later to the commander of Army Group F in Belgrade. (OB Suedost was simultaneously commander of Army Group E.) (See Chart 6)

Except for the results obtained from observing the British Eighth Army, German radio intelligence had little success, inasmuch as nothing important could be intercepted except British command messages, which could not be solved. German radio intelligence worked together with its Italian counterpart against the British. This co-operation was extremely cordial, but furnished few results of any importance. Turkey was covered in collaboration with the Bulgarian intelligence service. Turkish radio operations and cryptographic systems were extremely primitive and in no way met minimum standards of security. Radio intelligence furnished the usual

~~CONFIDENTIAL~~
~~Security Information~~

~~CONFIDENTIAL~~
~~Security Information~~

MS # P-038

-57-

information about the organization of the Turkish Army, its mobilization plans, and shipments of Allied military materiel, especially aircraft. The receiving units were informed in advance by radio of the arrival of the shipments. This information was, however, of no importance from the standpoint of German military operations.

The proposal to supplement radio intelligence operations, then directed exclusively against the east, by a chain of intercept stations directed toward the south and extending approximately from the Balearic Islands to Sardinia, Sicily, and Crete was rejected, since Anglo-American landings in Africa were believed out of the question because of the vulnerability of Allied supply routes to submarine attack. In addition, there were supposedly not enough intercept units available for such a precautionary measure.

French colonial radio traffic, with its fixed links in Morocco and Algiers, was intercepted by the Orleans Fixed Intercept Station, which was subsequently transferred to Montpellier. This traffic, including ciphers, as well as that handled by lower echelon units, presented no unusual difficulties. As was the case in France proper in 1940, colonial radio communication provided reliable clues to garrison locations and unit strengths. The known types of radio traffic in North Africa continued to function normally until the Anglo-American landings, thus providing no indication that a landing was imminent.

Long before the Allied landings in French West and Northwest Africa, German radio intelligence intercepted messages emanating from a large American air transport and supply organization in Equatorial Africa. The

~~CONFIDENTIAL~~
~~Security Information~~

~~CONFIDENTIAL~~~~Security Information~~

MS # P-038

-58-

formation and development of this organization could be followed in detail. It consisted of two east-west lines operating from coast to coast with lateral links and branch lines to the north. Information was thus secured regarding the establishment and operation of bases in central Africa, the arrival of air and sea transports from America at points along the west coast, transport flights across Africa, and the loading of freighters. The intercepts provided no direct indication of an impending landing. Nor were such conclusions apparently drawn by the Western Intelligence Branch or the Armed Forces Operations Staff on the basis of these striking intercepts concerning such a large-scale supply operation.

The Allied landings in French West and North Africa on 7 November 1942 came as a surprise because of the secrecy afforded by radio silence. The unpredictable sky wave radiation on the short wavelengths, preferred by the British and Americans for military traffic, was responsible for accidental success on the part of German radio intelligence. The intercept stations in Norway, the Netherlands, and France which covered the west, chiefly England, picked up almost all Allied messages following the landing and were able to work without the assistance of direction-finding stations to the south, since a sufficient number of localities were mentioned in Allied messages. On the first day of the landing the Bergen (Norway) Fixed Intercept Station received the messages with good signal strength. Bergen immediately recognized their importance and reported them to St. Germain. Since the traffic resembled that used at Dieppe, especially with regard to the use of colors to designate beachhead sectors, there was no longer any doubt that a landing had occurred.

~~CONFIDENTIAL~~~~Security Information~~

~~CONFIDENTIAL~~~~Security Information~~

MS # P-038

-59-

Even during the first few hours the landing forces were reporting "no resistance," and the like. It was apparent therefore that the French did not resist the landing but in fact assisted it in some places, whereas Vichy continued to report stubborn French resistance for days.

In spite of or because of the long distances, the signals in question were also well received in the St. Germain area, even including traffic between regiment and battalion, since the short wavelengths were used almost exclusively. A large volume of messages was received, which was not surprising in view of the strong Allied forces committed. There is nothing new to be said about enemy radio procedure at that time. In spite of all attempts at uniformity American traffic could still be distinguished from the British. The former was generally characterized by greater carelessness. Field codes and ciphers were solved and a large number of careless messages in clear text appeared once again.

German radio intelligence gathered information about the following points: all beachheads, the neutralization or desertion of French troops, the progress of the advance into the interior, some of the advance routes and objectives, supply problems, co-operation between air and ground units, the order of battle of the landing forces and their tactical organization during the advance. After the arrival of the first elements of General von Arnim's Fifth Panzer Army, reports were heard from armored reconnaissance elements about German positions, movements, and engagements. Added to these were the usual details, such as names of officers and reports on casualties, armament, and equipment; in short, the entire course of events was followed in detail by a branch of German communication intelligence

~~CONFIDENTIAL~~~~Security Information~~

~~CONFIDENTIAL~~~~Security Information~~

MS # P-038

-60-

that actually was assigned an entirely different mission on another front. It is hardly an exaggeration to say that during at least the first phase of this campaign almost one hundred percent of the German's information about the enemy in this new theater was provided by communication intelligence.

The next step was to forward this information to the German forces in Africa without undue loss of time. At that time OKH approved the essential features of the once-rejected plans for establishing a theater of operations (OB Suedwest) and the requisite measures were swiftly taken. First, an army intercept company, supported by a Luftwaffe communication intelligence unit, was sent to Taormina in Sicily, and later, for technical reasons, to Marsala at the western tip of the island. There the company operated quite successfully, since it was close to the front and the Americans still failed to observe radio discipline. This unit rendered valuable service to the German command.

In February 1943, the position of Commander of Communication Intelligence (Seven) was created with an evaluation center in Rocca di Papa, south of Rome, under OB Suedwest (Field Marshal Kesselring), whose headquarters was in nearby Frascati.

According to Chart 6 the Commander of Communication Intelligence (Seven) was in command of the following units: the remnants of the former intercept company which had been attached to the Panzer Army of Africa, together with the local Italian communication intelligence company, for operations against the British Eighth Army; one communication intelligence company in Sicily for observing the British First Army in Africa;

~~CONFIDENTIAL~~~~Security Information~~

~~CONFIDENTIAL~~
~~Security Information~~

MS # P-038

-61-

and the Montpellier station in France for intercepting French traffic in Africa. The latter unit was subsequently used at Rocca di Papa for other duties. The Commander of Communication Intelligence (Four) in Athens continued to direct his attention toward the east. In addition, surveillance of partisans in the Balkans was carried on.

Direction-finding operations against Africa were organized as follows:

D/F Network A: Headquarters in Sicily. Stations in Sardinia and Gabes, North Africa. Objective: British First Army.

D/F Network B: Headquarters in Gabes, North Africa. Stations in Sicily and Crete. Objective: British Eighth Army.

D/F Network C: Based at Rocca di Papa and Montpellier. Duties: to check D/F operations and to assign missions connected with the analysis of D/F data to networks A and B, or to individual D/F stations. (See Chart 6)

In the wide-spread operations of these units under the Commander of Communication Intelligence (Seven), safe and rapid inter-unit communication was just as essential to their effective operation as are communication media in general to all using agencies. Because of the nature of the theater of operations, radio communication was of the greatest importance. This was true of communication across water and desert, and also of that in Italy, where wire communication was restricted to the north-south trunk circuit, which was frequently interrupted. Since short-wave transmitters were required for such great distances and since the Army did not possess a sufficient number, the 70-watt short-wave transmitter used by the Navy

~~CONFIDENTIAL~~
~~Security Information~~

~~CONFIDENTIAL~~
~~Security Information~~

MS No. P-038 Chart 7

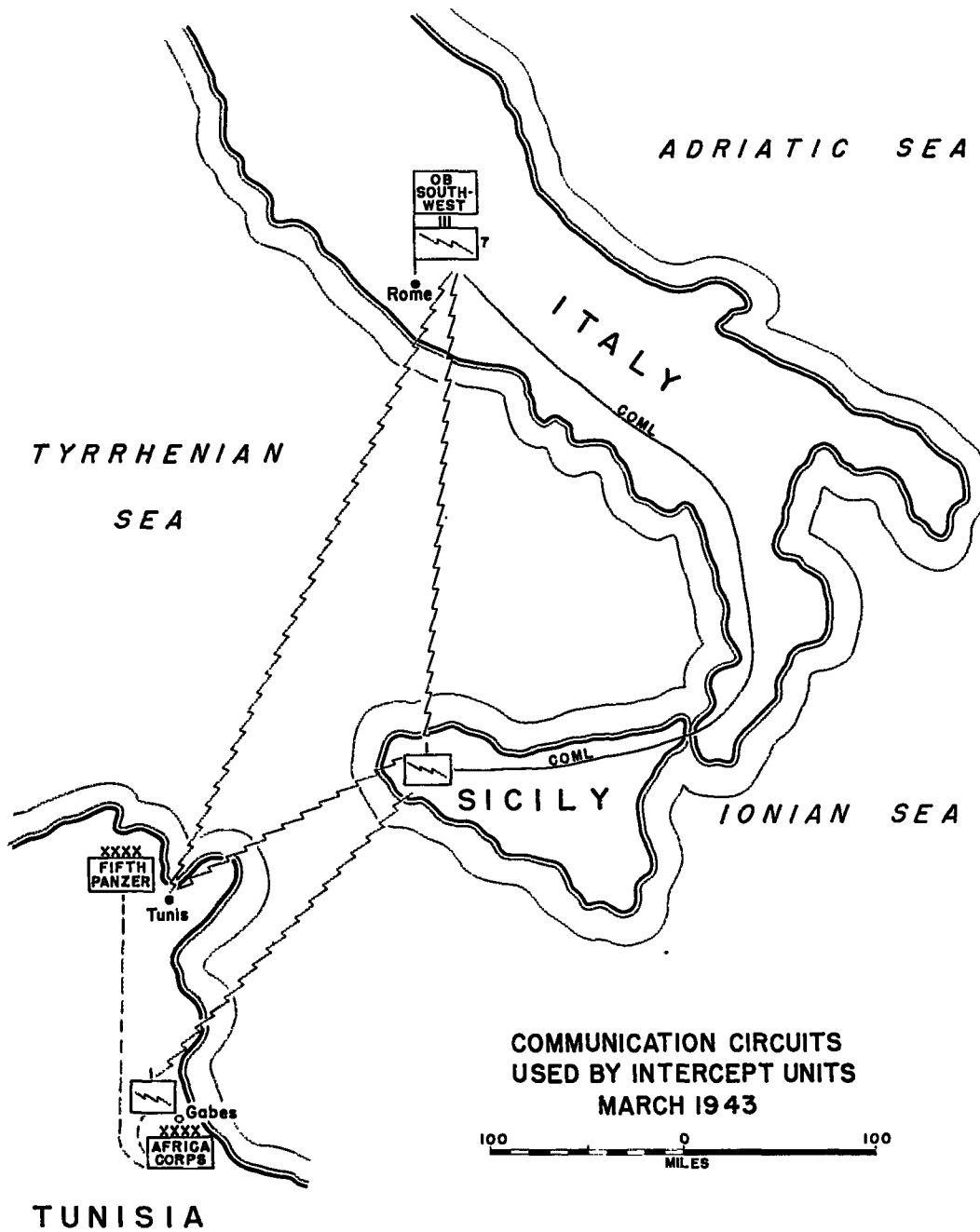

~~CONFIDENTIAL~~
~~Security Information~~

~~CONFIDENTIAL~~
~~Security Information~~

MS # P-038

-62-

was considered preferable and accordingly was procured. Its operation is shown in Chart 7. In addition to the communication circuits shown in this chart there were also special radio nets serving in the extensive direction-finding system. The Luftwaffe provided the Commander of Communication Intelligence with channels in the microwave ("decimeter") circuit between Sicily and Tunis, which was extended southward by an open wire line to the intercept company near Gabes. Similarly, the Luftwaffe furnished other channels by lending its radioteletype line between Rome and Sicily to Army communication intelligence. Since the evaluation centers also needed the original texts of radiotelephone and telegraph messages, these were forwarded by the daily Rome-Sicily courier planes and the courier plane which came from Africa every two days.

In early March 1943 the Germans were awaiting the attack of the British Eighth Army against the Panzer Army of Africa and its Italian components, which had withdrawn along the coast all the way from Egypt to the Gabes area. However, there was no clue as to when the attack would begin. Then on 13 March the following message was picked up from a British battalion: "Remember to observe radio silence until 2200 hours 16 March." The Commander of Communication Intelligence immediately reported this to the chief of staff of the army group, adding the question: "Does this indicate a major operation?" When a similar message was picked up the following night, Kesselring was awakened, whereupon he flew to Africa in order to examine the defense preparations and to brief his commanders. The attack began, as predicted, on the evening of 16 March, and found our troops prepared to defend themselves.

~~CONFIDENTIAL~~
~~Security Information~~

~~CONFIDENTIAL~~
~~Security Information~~

MS # P-038

-63-

Because of the favorable results obtained by communication intelligence, its relations with all Army and Luftwaffe headquarters were excellent. For example, at a conference in the headquarters of OB Suedwest, the Commander of Communication Intelligence reported a British message just received which revealed that there was a considerable traffic jam in a certain wadi (dried-up river bed), the location of which could not be determined by cryptanalysis but could be surmised, since several columns were blocking the wadi. Kesselring radioed orders for planes to reconnoiter this wadi. Air reconnaissance confirmed the intercept while the conference was still in progress, and a short time later a report was received that the troop concentration had been successfully bombed.

One day, because of a breakdown in tactical signal communication and the resulting lack of reports, the operations officer (G-3) for OB Suedwest was without any information concerning the latest front-line developments. Communication intelligence was able to show him its own accurate situation map, which had been compiled exclusively from intercepted reconnaissance reports made by Allied units.

Other intercepted messages affected military discipline, as, for example, when the British stated that they could observe the course of the German positions southeast of Sfax because the German troops were not using any cover or concealment while entrenching. Another message gave the exact number of German vehicles because their windshields were not camouflaged and reflected the sunlight.

Errors in interpretation also occurred. However, such instances were rare, since all unconfirmed reports were given with reservations. For

~~CONFIDENTIAL~~
~~Security Information~~

~~CONFIDENTIAL~~~~Security Information~~

MS # P-038

-64-

example, prior to the invasion of Sicily a British message spoke of a successful landing. Since only one direction-finding team was available, only one bearing could be taken. The reading suggested a point on the southern coast of Sicily. As was subsequently revealed, no landing on Sicily had taken place, but a landing exercise had been carried out on islands off the African coast which lay in the path of the bearing taken. This experience made the intelligence analysts more cautious in their judgments. As a result, one of them did not immediately report a landing on the Italian mainland, from Sicily, because he believed that this, too, was a training exercise. In this case, however, it was the real invasion.

The Communication Intelligence Commander's request to save the intelligence company in Africa from impending capture and thus preserve it for future action by transferring it to Italy was turned down because of Hitler's order that no men or equipment were to be evacuated from Africa. Thus, only a small part of the valuable personnel and radio equipment could be saved. The conduct of the personnel of the company, with whom radio contact was maintained until the arrival of the enemy tanks, was excellent. They reported that they had destroyed all valuable materiel, and that every man was aware of his duty after being captured.

XI. Sicily and Italy (1943 - 45)

Since enemy air superiority seriously hampered German air reconnaissance during the fighting in Sicily and southern Italy, communication intelligence played a more and more important role. One corps commander

~~CONFIDENTIAL~~~~Security Information~~

~~CONFIDENTIAL~~
~~Security Information~~

MS # P-038

-65-

summed up this trend by saying he no longer needed an intelligence officer (G-2) for compiling reports on the enemy situation, since the only available sources of information were the intercepts furnished by communication intelligence.

In the course of the numerous landings during the following months the enemy was again able to achieve surprise by maintaining radio silence. In between landings, however, German communication intelligence was able to gain information that was instrumental in countering these landings.

During the fighting in Sicily an intercepted message, revealing a planned minor landing on the northern shore of the island, was transmitted not only to OB Suedwest and to Korps Hube, which was then fighting in Sicily, but also to the intelligence officer of Luftwaffe commander, Field Marshal von Richthofen. The intelligence officer did not report this message immediately but waited until the regular staff meeting, which was held later. Consequently, the Luftwaffe was unable to carry out counterattacks in time. Richthofen was furious and immediately ordered that in the future all such reports should not go through channels but should be sent directly to him or his chief of staff and simultaneously also to the Luftwaffe field agencies concerned. During a similar but bigger landing, which was supported by naval artillery, another message intercepted by radio intelligence resulted in the timely and effective bombing of the enemy's ships offshore, which compelled him to call off the operation.

During the fighting at Enna in Sicily a German war correspondent picked up a broadcast concerning radio intelligence and its successes

~~CONFIDENTIAL~~
~~Security Information~~

~~CONFIDENTIAL~~
~~Security Information~~

MS # P-038

-66-

in Sicily which had been foolishly sent out by German civilian stations. After only a few days the conduct of the Allied radio operators revealed that this indiscretion had not escaped the enemy's attention and that he was taking countermeasures.

The Germans were able to withdraw the radio intelligence company stationed near Marsala in Sicily to the Reggio area without loss of personnel or equipment and without interrupting operations. Later, the same company could carry out additional leap-frog moves to the Salerno and Rocca di Papa areas.

In contrast to the former decentralized method of employing radio intelligence units, a more efficient policy of centralization was now instituted, and this radical though effective change in procedure was continued up to the end of the war. This centralization was in keeping with the geographic features of the Italian theater, as well as the more conventional type of warfare carried on there. The long peninsula, bounded on both sides by the sea, reduced the opportunities for local direction-finding operations. In addition, reception was unfavorably influenced by the Apennines and later the Alps. Instead of enemy flank attacks, the Germans expected enemy landings on the east and west coasts, such as were later carried out on a large scale at Salerno and Nettuno. With shorter distances to the target areas, operations could be kept under close control with the help of good communication. Having been selected as the ideal method, centralized communication intelligence intercepted and evaluated all types of traffic at one place, from which the information was forwarded to all interested agencies over short lines of commun-

~~CONFIDENTIAL~~
~~Security Information~~

~~CONFIDENTIAL~~~~Security Information~~

MS # P-038

-67-

ication. The evaluation personnel of the companies worked together with the personnel of the evaluation center, thus increasing the latter's efficiency.

The companies were stationed from three to nine miles apart, engaged only in intercepting and formed part of a large intercept center that was controlled by those in charge of evaluation. The Commander of Communication Intelligence maintained personal contact with OB Suedwest (Army Group C) and with the Tenth and Fourteenth Armies. In the vicinity of various corps headquarters short-range intelligence platoons were stationed, which co-operated with the respective corps intelligence officers. Here, too, a solution for short-range intelligence problems was found that subsequently served as a model for other theaters.

The problem of quickly informing front line units of all intelligence reports concerning them was solved in other theaters by drastic decentralization whereby small teams were located in the vicinity of division staffs. The time-consuming route through the chain of command was thus avoided. In Italy, however, centralized intercept methods could work with greater technical efficiency, and a large evaluation center could provide better results, in view of the many languages spoken by the enemy. Thus, all tactical intelligence information of importance to the lower echelons was encrypted in a special cipher and broadcast by a powerful station, with the exception of secret operation reports, which were forwarded through the customary channels. These radio warnings saved many lives, especially among artillerymen, and were gratefully received by all. They generally referred to German positions and movements recognized by the

~~CONFIDENTIAL~~~~Security Information~~

~~CONFIDENTIAL~~
—Security Information—

MS # P-038

-68-

enemy, and hence to impending air or ground attacks, as well as enemy orders or requests for artillery fire. The German troops were thus able to avoid the attacks in time.

After German radio intelligence had previously reported messages from the Italian Navy indicating Italy's approaching defection and the sailing of its fleet, it confirmed the accomplished fact of Italy's defection at end of July 1943 by means of an intercepted British radio report. The headquarters of OB Suedwest, together with the units of communication intelligence, were deprived of their land lines to Germany because the rebels had occupied Rome. In addition, they were confronted by several Italian elite divisions which displayed a hostile attitude. As was later disclosed through some remarks made by Churchill, there existed the danger of an Allied airborne landing for the purpose of eliminating the headquarters, a plan which was canceled at the last moment. Until the situation could be brought under control by German troops, the Commander of Communication Intelligence had to occupy a fairly extensive defense sector with a large part of his personnel in order to protect the headquarters, while specially selected men carried on the work of radio intelligence, so important at this particular time. Despite the circumstances, they were able to furnish some valuable reports. Although there was not a sufficient number of planes available, OKW ordered the immediate transfer by air of the entire communication intelligence organization to Army Group B stationed along the southern slopes of the Alps. The order was rescinded because of Kesselring's objection.

In early 1944 the German defense forces were opposed by the British

~~CONFIDENTIAL~~
—Security Information—

Eighth and the American Fifth Armies under the 15th Army Group. These troops were composed of British elements from every part of the Empire. Americans (both white and Negro), French (Moroccans), Poles, a Jewish brigade, Brazilians, and Italians. Even Turks were expected to join them in the end. This variety of nationalities frequently confounded the short-range intelligence teams of the divisions, since they could not have translators for each language. Such teams were, therefore, less important in Italy than in other theaters and their work was largely replaced by the broadcasting of radio warnings.

In evaluating the results obtained by German communication intelligence in this theater during the last year of the war it should be noted that the enemy signal personnel had learned in the course of the war to respect German communication intelligence. The Germans now had to strain every effort to detect and exploit the inevitable weaknesses in Allied radio communication. Messages which offered little prospect of success were now given secondary consideration. These were chiefly command messages from division to higher headquarters. Main emphasis was placed on front-line traffic forward of division. The difference between long-range and short-range intelligence had gradually disappeared, since the former relied more and more on the information obtained by intercepting enemy radio traffic in the forward lines.

In Italy the British and Americans had co-ordinated their radio techniques to such an extent that there were hardly any differences to be noticed. Apart from pronunciation and subject matter their respective transmissions could be distinguished only by a few operating character-

Dr. Pettengill called to say -

MS #P 038 - Historical Div.

RE Footnote on P. 70 - Mr. Blough a translator in the Historical Section says that the German Translator of the book was a Mr. Klein and J. B. Robinson was editor both from Karlsruhe and presumably still there. The book was translated here by the Army but the footnote ~~was~~ is as originally translated by Klein and Robinson. A partial source of the translation can be found on p. 203.

~~CONFIDENTIAL~~~~Security Information~~

MS # P-038

-70-

istics and some differences in troop designations. It was simpler to recognize units which did not speak English. The French used their old peculiar methods and were fairly easy to identify, while the Brazilians offered no difficulties at all.

In all cases it was possible to obtain information from mistakes made by the enemy. The sending of messages in clear text, which were often unnecessary, furnished unit designations, terrain data, and officers' names. Attempts to disguise operating signals and grid co-ordinates were still unsuccessful. The cryptographic systems used by the higher echelons continued to resist analysis, but many field ciphers could be broken. In this connection it should be acknowledged to the credit of the Allies that only a few of these messages in field ciphers revealed events of tactical or strategic importance, at least not directly. On the other hand, it was frequently possible to draw conclusions. Only the French went their own way in cryptographic matters, and their systems could be easily solved. They used a small cipher device, probably of Swedish origin, the results of which were not difficult to solve. It was even possible to break the large French cipher device under certain circumstances. The cryptanalysis section of the communication intelligence clearing center in Italy worked out a procedure which enabled the evaluation units in Italy to solve difficult mechanical ciphers. The French employed in addition so-called "worm ciphers" (Wurmschlüssel)*, which were also regularly broken.

* Tr: A cryptographic device by which the key to the general system was determined by arbitrarily selected passages in some inconspicuous book carried by the agent, such as a popular novel. It was called "worm" because the key passages in question began suddenly in some apparently irrelevant part of the text, like an earth worm appearing above the surface of the ground. It continued for a certain specified number of letters or sentences and then stopped.7

~~CONFIDENTIAL~~~~Security Information~~

On the whole, however, enemy radio communication was so good that German radio intelligence was confronted by a crisis in March 1944, since it had become almost impossible to ascertain Allied intentions in time. It had also become difficult to recognize the order of battle during the withdrawal and transfer of units, and changes in command. But then, as subsequently happened in France, the Allied air forces came to the rescue.

Intensive study of intercepts covering a fairly long period disclosed a definite relationship between preparations for offensive operations and the assignment of air liaison officers to front line divisions. Assault divisions which did not have an air liaison officer were assigned one, while other divisions were assigned a second one. The air liaison nets were easy to intercept, since the system used was of a lower quality than that employed by the British and American ground forces. This knowledge in turn enabled the Germans to predict accurately when enemy attacks would begin. German Army interception of the Allied strategic air force revealed the points of main effort of reconnaissance flights, and target areas, which helped to clarify the enemy's over-all plans.

Some trivial details furnished information to communication intelligence, as is shown by the following examples: An impending attack against German defenses in the Naples area was detected in time because a small supply unit mentioned that rum was to be issued on a certain day. Since it was known that the British issued rum to their troops before an attack, it was possible to warn the German defenders.

The following remark was heard over an American net: "Italians can only be used as waiters and postcard salesmen." This wholly superfluous

~~CONFIDENTIAL~~
~~Security Information~~

MS # P-038

-72-

message, supplemented by D/F data, confirmed the presence of an American unit near Naples, as had been previously suspected.

The following was heard from a British station at Lake Commachio: "The German troops are retreating in a hurry and even the Italians are advancing." The presence of the British unit was already known, but this message confirmed the first employment of Italians in combat on the Allied side.

The radio operator of a French unit described his anticipated amorous adventures in Naples. No French units had previously been detected at the point from which he sent his message.

The Canadian and Polish divisions were known as assault troops. Their appearance at the front and the narrow segments of the line occupied by them were additional indications of an impending attack at that point.

It is difficult to understand why the Allies, at least during position warfare in this theater, failed to mask their offensive ground operations by maintaining radio silence just as they did during surprise landings. Unlike the situation in the desert, their telephone lines in Italy were certainly adequate for this purpose. As was the case in Russia, this carelessness was probably due to a feeling of absolute superiority. Nevertheless, the manner in which enemy radio operations were conducted offered the weaker defenders much information which cost the attackers losses which could have been avoided.

XII. Defense of Western Europe (1944 - 45)

Following the spring of 1944 German communication intelligence in

~~CONFIDENTIAL~~
~~Security Information~~

~~CONFIDENTIAL~~
Security Information

MS No. P-038 Chart 8

ORGANIZATION OF RADIO INTELLIGENCE UNITS UNDER O B WEST

(A) At The Start Of The Allied Invasion Of France, June 1944

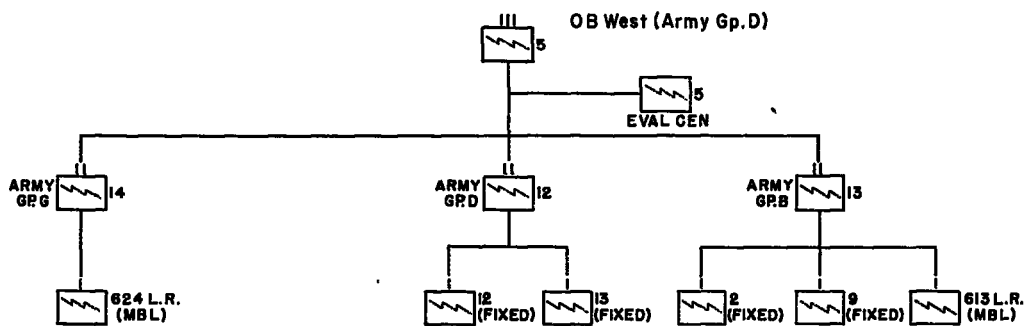

(B) After 1 January 1945

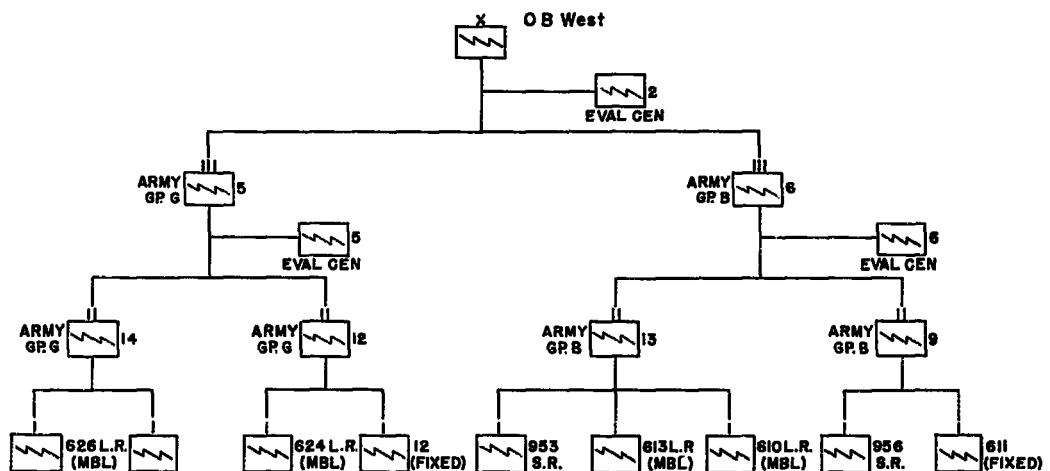

Note: Headquarters Designations Beside Signal Unit Symbols Indicate Physical Location Of The Signal Unit; Long Range Is Indicated By The Initials L.R. And Short Range By The Initials S.R.

~~CONFIDENTIAL~~
Security Information

~~CONFIDENTIAL~~~~Security Information~~

MS # P-038

-73-

Italy and France noticed a shift in heavy enemy concentrations from the Mediterranean area to England. American and British elite divisions, which had previously been observed in southern Italy or elsewhere in the Mediterranean theater, appeared in the British Isles. The following is an example of German intercept work during that period: An American airborne division (the 82d?) had been reported for quite some time in southern Italy when it suddenly disappeared. About three weeks later over a hitherto unidentified net in England there was transmitted a reference to the search for a soldier against whom a girl in the United States had instituted paternity proceedings. The shipment number of this soldier tallied with the code designation used by the missing airborne division. When communication intelligence reported this finding and suggested that the airborne division might have been transferred to England, the Armed Forces Operations Staff replied facetiously that the division had most likely been transported by submarine, but that no transports of this kind had been observed near Gibraltar. Nevertheless, the new radio net was put under special observation for any characteristics of this airborne division, and indisputable evidence of its presence in England was soon secured. It subsequently turned out to be one of the first invasion units to be reported.

The methods employed in intercept operations against Great Britain did not change substantially during the last eighteen months of the war. Chart 8a enumerates the German radio intelligence units which were available in 1944. A subsequent comprehensive evaluation prepared some time after the start of the Allied invasion showed that approximately ninety-five

~~CONFIDENTIAL~~~~Security Information~~

~~CONFIDENTIAL~~
~~Security Information~~

MS # P-038

-74-

percent of the units which landed in Normandy had been previously identified in the British Isles by means of intensive radio intelligence. Thus, one may conclude that the information provided by communication intelligence was quite adequate and that the German Supreme Command was in a position to calculate the strength of the enemy forces. Locator cards, regularly issued by the communication intelligence control center, contained precise information about newly organized divisions, and the appearance or disappearance of radio traffic from and to specific troop units.

The intercepted radio activity during the numerous landing exercises furnished a picture of the projected invasion procedure. It was impossible, however, to obtain any clue as to the time and place of the landing. The radio picture did not change noticeably until the last day before the invasion. All previously known and observed types of traffic continued as usual. No radio deceptions were recognized. No kind of radio alert was observed before the landing. According to later reports the first wave sailed on short notice.

The Allies scored a great surprise on 6 June 1944 by the imposition of radio silence. Any different action would have been a grave blunder not to be expected of an enemy who had had five years of varied wartime experience, both good and bad, with German communication intelligence and who after a long period of preparation was now launching the decisive battle of the war.

The German radio intelligence organization in the West had been prepared for the invasion during the preceding months. Its actual beginning, therefore, brought no special changes. The entire organization was

~~CONFIDENTIAL~~
~~Security Information~~

~~CONFIDENTIAL~~
~~Security Information~~

MS # P-038

-75-

so well integrated that it could handle the additional work-load. Gradually all monitoring of unimportant areas, such as Ireland, Spain, Portugal and Brazil, was discontinued in order to save personnel and equipment and to release all available men for intercepting the traffic of the Allied forces that had landed. Since the evaluation data had been distributed to all units, it was possible to transfer the intercepting of new radio traffic from one unit to another at short notice. This was only possible, however, because all the units had thoroughly trained and experienced personnel. Breakdowns in the command net caused by enemy air attacks reduced the speed with which intelligence results were transmitted, but this difficulty was overcome by a pre-arranged plan which was put into effect all along the line from the unit furthest forward back to the communication intelligence control center.

After the initial landings, long-range intelligence at first produced only minor results. This was explained by the fact that the Allies did not wish to offer any clues to enemy radio intelligence and therefore restricted their radio communication. Moreover, the short distances within the beachhead areas probably permitted the issuance of verbal orders and reports. In addition, the enemy was able to use telephone connections, which were not disrupted by any Luftwaffe interference. The expansion of the beachheads resulted in the transmission of so many radio messages that a fairly clear picture of the enemy situation was speedily obtained. An even greater wealth of information was provided by short-range radio intelligence and divisional combat intelligence. The signal officer for OB West moved his short-range intelligence company to Seventh Army headquarters

~~CONFIDENTIAL~~
~~Security Information~~

MS # P-038

-76-

near Caen to improve short-range intelligence operations. The reports on the situation emanating from communication intelligence about forty-eight hours after the beginning of the invasion listed most of the enemy divisions and included data on the enemy army group then in command.

The postwar press gave much attention to the opinion expressed by General Jodl, the Chief of the Armed Forces Operations Staff, who said that a second landing was expected north of the Seine and that therefore the German reserves and the Fifteenth Army stationed in that area were not immediately committed in a counterattack. The information obtained by communication intelligence did not support this assumption. The chief of the control center of Communication Intelligence West was asked to express his personal opinion on this matter during a conference of the Western Intelligence Branch. He said that a comparison of the number of units already recognized with those previously identified in Great Britain permitted the conclusion that most of the Allied forces had already been landed and that the remaining ones were insufficient for a second landing. Any still uncommitted units would be needed to feed the current battle. This opinion was shared by the Western Intelligence Branch, but was in contradiction to that of the Armed Forces Operations Staff. The estimate of the situation was given some validity by the fact that a short time after the beginning of the invasion a British landing craft had been captured near Boulogne. However, it seemed obvious that this enemy craft had lost its way.

When, during the first few days after the beginning of the invasion, the Allies created the impression of a second airborne landing by dropping

~~CONFIDENTIAL~~~~Security Information~~

MS # P-038

-77-

dummy paratroops over Brittany at night, communication intelligence offered evidence to the contrary because of the complete absence of enemy radio traffic in the alleged landing area.

It should be noted that unfortunately not only in this instance but throughout the war General Jodl, as well as Hitler himself, frequently showed a lack of confidence in communication intelligence, especially if the reports were unfavorable. However, orders were issued as early as the time of the Salerno landing that all favorable reports should be given top priority and dispatched immediately, regardless of the time of day. Moreover, Communication Intelligence West was required to furnish a compilation of all reports unfavorable to the enemy derived from calls for help, casualty lists, and the like. When, during the first days of the invasion, American units in particular sent out messages containing high casualty figures, the OKW was duly impressed. In contrast, the estimate of the situation prepared by the Western Intelligence Branch was absolutely realistic and in no way colored by optimistic hopes.

As already mentioned, short-range radio intelligence and combat intelligence provided such an abundance of information that even in Normandy any attack of division strength and greater could be predicted one to five days in advance. The American field cipher device was compromised. To be sure, messages enciphered by this system could at first be solved only after a delay of from two to four days. Later on, when more data had been gathered, only a few hours were needed. The British cryptographic service was unchanged: while the army was as efficient as ever, the RAF continued to be careless. Here, as in Italy, communication intelligence maintained

~~CONFIDENTIAL~~~~Security Information~~

~~CONFIDENTIAL~~
~~Security Information~~

MS # P-038

-78-

routine interception of the messages sent by air liaison officers attached to British Army headquarters, who thereby revealed the intentions of the enemy command. There was no cryptographic co-operation between the Army and the RAF, nor was there any unified control in this field.

The following example shows how combat intelligence was carried out by the communication intelligence team of a division. Early in August 1944, west of Thury-Harcourt, the British 5th Armored Division attacked in the sector of the German 277th Infantry Division, which was commanded by the author. The short-range radio intelligence team rendered excellent service.

The following is a description of a typical day of combat observations: In the early morning there was heavy ground fog and little fighting. At about 1000 hours the weather cleared and several enemy reconnaissance planes appeared, which reported in the clear to the division air liaison officer all German movements in villages, in established positions, on roads, and at certain terrain features. The gridded map used by the British for reporting terrain features had previously fallen into German hands. In the German experience British artillery would open fire on these objectives before launching the attack planned for that day. Commanders in the target areas were immediately warned of the expected artillery attack by telephone or motorcycle messenger. Twenty or thirty minutes after the air reconnaissance -- the time required by the British artillery for preparation -- concentrations of several hundred rounds each were delivered at a rapid rate of fire against the reported objectives. Similar warnings of artillery attacks could be issued through the broadcasting facilities.

~~CONFIDENTIAL~~
~~Security Information~~

~~CONFIDENTIAL~~
~~Security Information~~

MS # P-038

-79-

After this introduction to the combat activities of the day, the enemy tank crews began to chatter about their preparations, reconnaissance results, and attack objectives. As soon as the assembly areas of the British armor were recognized the division artillery regiment concentrated its fire on these points. The enemy usually reacted immediately with messages such as "Fritz has seen us. Call off the attack for today and return to your initial assembly areas."

The stupendous fire delivered by the Allied naval artillery in conjunction with the artillery of the divisions and corps in the beachhead, whose supply of ammunition seemed inexhaustible, as well as the effect of carpet bombing, created a "radio psychosis" among the German troops. They believed that every tap on the key of a field radio was being pin-pointed by small enemy direction finders and that this was the reason for the enemy fire. Consequently, German radio activity was discontinued. It took quite some time to persuade the troops that, in view of the large number of German transmitters employed at the front, enemy direction finding could not possibly be as effective as they feared and that the enemy fire, moreover, was equally heavy at all points.

It is remarkable that the comparatively weaker concentrations of fire delivered by Germans had the same psychological effect on enemy troops, as was revealed by captured documents. The British troops, also, believed that all their radio emissions were being plotted by direction finders. Actually they were unaccustomed to the sudden concentrations of fire in battalion or regimental strength which the Germans delivered without adjustment fire in order to prevent detection by flash and sound-

~~CONFIDENTIAL~~
~~Security Information~~

~~CONFIDENTIAL~~
~~Security Information~~

LS # P-038

-80-

ranging instruments. Captured documents revealed that the British attempted to dispel this same apprehension on the part of their troops, which, from a technical standpoint, was unwarranted.

As in the Italian theater, the German divisions were grateful for the warning messages which immediately conveyed to them any relevant information obtained by radio intelligence. Even today quite a few German artillerymen will tell how this system saved their lives.

The Canadian, British, and American zones of action could be readily distinguished by the characteristics described earlier in this study. The plans for the Allied break-through at Avranches and details concerning the battle of the Falaise Pocket were known through radio intelligence.

When the communication intelligence units were forced to keep on the move during the later phase of the campaign their own communication nets were jeopardized. Just as in the case of the command nets, disruptions were frequent, and the information obtained from radio intelligence sources decreased steadily. This was particularly true during the retreat of Army Group G following the Allied landings in southern France. In place of the communication intelligence unit previously stationed in that area, the German organization in Italy covered the advance of the enemy forces from the south of France. Its reports were transmitted to OB West and to the Western Intelligence Branch. On several occasions enemy radio messages revealed that German units had been cut off by the Allied advance. In such instances immediate attempts were made to re-establish contact with the encircled forces.

In spite of low personnel strength and disrupted signal communication,

~~CONFIDENTIAL~~
~~Security Information~~

~~CONFIDENTIAL~~
~~Security Information~~

MS # P-038

-81-

German communication intelligence proved capable of covering the Allied forces' advance to the Rhine by reporting the approximate composition and strength of the enemy units as well as the boundaries between forces of different nationality. Battle-tested divisions were more careful in their radio operations than new ones. The Americans generally observed less radio discipline than the British, and thus provided a better source of information. During the first excitement of the invasion, both the Americans and the British often transmitted in the clear. The Canadians, who formed the numerically weakest landing contingent, supplied quantitatively the least information. Among the American forces, Patton's army was the easiest to observe.

The U.S. Seventh Army, advancing from southern France, offered the greatest difficulties, since it maintained exceptional radio discipline and cryptographic security. It could be plotted only by intensive D/F operations. This fact may perhaps be attributed to the Seventh Army's previous combat experience in Africa, Sicily, and southern France, where its forces had learned to deal with German communication intelligence. In any event, the Seventh Army furnished an interesting example of a major command's having trained its subordinate unit commanders and signal officers to observe such a high degree of radio discipline that the sources of enemy intelligence were restricted to a minimum.

Another American Army, possibly the Third [sic], could be easily observed, because its messages were transmitted in a careless manner and because it used very primitive ciphers below division level. In addition to revealing valuable tactical information, this army gave away its

~~CONFIDENTIAL~~
~~Security Information~~

~~CONFIDENTIAL~~~~Security Information~~

MS # P-038

-82-

passwords to the Germans twenty-four hours in advance.

The reports, which many units transmitted at the same time every morning and evening from identical stations, facilitated the surveillance of intra-division communication between infantry, artillery and quartermaster units, and thus also between division and corps. The regular pattern of the communications also facilitated the solving of new ciphers soon after their application.

At that time messages enciphered with the small American cipher device could be easily solved, since many of these devices were in German hands, so that ten or twelve messages sufficed for a solution.

The Free French Army's movements could be observed without difficulty. Its radio system had hardly improved since 1940, not even with regard to the ciphers, which were easily solved. The gateway through which Leclerc's division had entered Paris became known to the Germans from an intercept even before the capital was actually occupied. The British airborne landings near Arnheim impressed the Germans with the necessity of devoting more attention to the higher frequencies.

When the front lines were stabilized along the West Wall and the Vosges Mountains, five communication intelligence companies and several headquarters units were withdrawn from the shortened Eastern Front and transferred to the West. (See Chart 8b)

With the assistance of the previously employed units the newly-arrived ones soon became adjusted to operations in the western theater. They proved especially useful in long-range interception to which they had been accustomed by years of experience in Russia. Their comparison

~~CONFIDENTIAL~~~~Security Information~~

~~CONFIDENTIAL~~
~~Security Information~~

MS # P-038

-83-

of the two theaters was of great interest. They believed that intercepting, evaluating, and solving British and American radio messages presented fewer difficulties than those they had encountered in Russia. Their contention was that the Russians used better methods to render their traffic secure, sent fewer messages in clear text, maintained stricter radio discipline, and posed a greater problem to German direction finders than did their Western Allies.

A new kind of intercept operation was carried out in the region of the Upper Rhine by ultrashort wave detachments, which hitherto had not

*
Tr: A literal translation of Ultrakurzwellen, the precise limits of which within the radio spectrum are not known. The term possibly embraces all frequencies above 30 megacycles.

had enough receivers. In the Baden-Baden area, on the western edge of the Black Forest they heard enemy armored traffic as far away as the Western Palatinate and Saarbruecken, and from the Feldberg (in the Black Forest) they intercepted messages from the Colmar-Mulhouse area. The results were forwarded without delay to the interested divisions by means of a collective call arrangement such as was employed by army group and army headquarters. Because of the method of propagation used, the German transmissions could not be picked up by enemy short-range intelligence units, for instance those operating at the eastern edge of the Vosges Mountains.

In order to prevent the dissemination of communication intelligence results to unauthorized agencies, the radio warning service employed three different cryptographic systems, one for the army group and armies,

~~CONFIDENTIAL~~
~~Security Information~~

~~CONFIDENTIAL~~
~~Security Information~~

MS # P-038

-84-

another for the corps, and a third one for the divisions. Each higher echelon was also acquainted with the system used by its subordinates. Even during the fighting along the West Wall, in fact until the end of the war, the results gathered by short-range communication intelligence teams attached to newly activated or reorganized divisions were always in proportion to the interest shown by the respective division commanders, the intelligence officers, or the signal battalion commanders. All the divisions which took an active interest in efficient short-range intelligence operations were remarkably successful against an enemy who was becoming more and more careless.

Especially interesting was the information obtained by communication intelligence during the Ardennes offensive. Before the German surprise attack it was evident that the enemy was not cognizant of the German preparations, since the assembled armies -- the Fifth and Sixth Panzer Armies -- observed radio silence. Communication intelligence clearly recognized the composition and low strength of the American units in the sectors which were to be attacked. The enemy had not fortified his lines or placed any reserves in readiness. On the morning of D Day, 16 December 1944, a message in clear text from the U.S. First Army stated that the Germans had overrun the American positions and caught the troops by surprise "while asleep." Then followed reports of U.S. withdrawals and information about the furthest points of advance reached by the German armored spearheads, as well as reports of heavy losses.

Soon afterward, German radio intelligence scored another great success which, though it could no longer be exploited operationally, might have led

~~CONFIDENTIAL~~
~~Security Information~~

~~CONFIDENTIAL~~~~Security Information~~

MS # P-038

-85-

to heavy American losses. This was the result of a serious blunder on the part of the Americans. A few days after the offensive began, a new net of the American military police was picked up. It was established beyond a doubt that MP units with radio transmitters had been stationed at all important road crossings, in fact, along all main rear area traffic arteries. They reported all major troop movements so that German communication intelligence was able to ascertain very quickly that troop units were being transferred to the Ardennes break-through area from all zones of action, except the French. The MP's used an easily broken cipher intermingled with a good deal of clear text -- probably for the sake of speed -- and thus provided the Germans not only with information about the composition of U.S. troops but also an accurate picture -- by mentioning advance guards, march velocities, and column lengths -- of the time when the German thrust could be expected to meet with increasing resistance. It was also perfectly clear to the Germans that these reinforcements were not made up of makeshift emergency units, but that the Americans were throwing in complete formations, including even some elite armored divisions. By so doing they indicated how confident they were that the Germans would no longer be in a position to attack those parts of the front from which these troops had been withdrawn.

This phone and CW traffic provided additional valuable information later on, for example, when radio intelligence was able to predict the transfer of a U.S. armored division to the Liège - Aachen area twenty-four hours in advance.

German communication intelligence continued to function smoothly in

~~CONFIDENTIAL~~~~Security Information~~

MS # P-038

-86-

the West during the subsequent course of events up to the end of the war. The Germans always knew well in advance about enemy concentrations, such as the one at the Remagen bridgehead, and about the direction of intended armor thrusts. They had no difficulty in discerning, for example, where and with which divisions General Patton intended to strike. The enemy gradually abandoned caution with the result that many messages of a highly classified nature were sent in clear text. The intelligence officer of Army Group West, as well as Field Marshal Kesselring, estimated that the information obtained by their communication intelligence amounted at that time to 95 percent of the German enemy intelligence, inasmuch as air reconnaissance was then a thing of the past, very few prisoners were captured, and agents could no longer get behind the enemy front.

Because of the growing German impotence on all fronts, the command was unable to exploit the results of communication intelligence in proportion to its great value. Because of the overwhelming Allied superiority in manpower and materiel during the last years of the war, the value of German communication intelligence was largely theoretical.

XIII. Russian Front (1941 - 1945)

(The events in the area of Army Group South are described by Colonel Randewig, formerly Commander of Intercept Troops for that army group.)

The vastness of European Russia, its dearth of good roads, the great distances which had to be traversed, the lack of high-capacity long-distance commercial teletype circuits, as well as the shortage of military telephone apparatus and cables, compelled the Soviet Army to make a far greater use

~~CONFIDENTIAL~~~~Security Information~~

MS # P-038

-87-

of radio communication than was necessary in the armies of the highly industrialized Western countries.

During 1941-42 German radio intelligence concentrated mainly on long-range operations, which in spite of many difficulties provided the German command with important information about the enemy.

With the conclusion of pre-war intelligence operations, the task of observing Soviet radio traffic was assigned to the Commander of Intercept Troops East in Posen. After the Polish Campaign he was put in charge of the three permanent intercept stations at Warsaw, Koenigsberg, and Breslau, and after the Campaign in the West, the 3d, 7th, 9th, and 18th Intercept Companies were put at his disposal. He and all his intercept units were placed under Army Group B (subsequently Army Group Center) when it took command of German forces in the East in July 1940.

In May 1941, during the course of the military preparations against Russia, the eastern border of German-dominated territory was divided into three army group areas, designated North, Center and South. The intercept units were placed under the command of the respective army groups in whose area they were stationed. The intelligence information obtained up to that time was turned over to the new commands.

According to instructions, the efforts of the intercept units were to be directed chiefly at ascertaining the organization and distribution of forces of the Soviet Army and Air Force in European Russia west of the Ural Mountains. The missions of this intelligence were to be as follows:

a. Analysis of Operating Techniques

This phase was to provide precise information on current radio tech-

~~CONFIDENTIAL~~~~Security Information~~

~~CONFIDENTIAL~~
~~Security Information~~

MS # P-038

-88-

niques, which were not substantially different from those used before 1939.

b. Analysis of Net Structure

This was to reveal the relationship between the command nets of the military districts and their occasional overlapping with the nets used by the corps in the fields. In addition, it was to furnish especially important information on the organization of corps and division nets, some of which had been revealed when the Russians occupied Bessarabia.

c. Cryptanalysis

This phase was to deal with the solution of all field ciphers which were encountered (chiefly groups of two or three numbers) and with methods for solving higher-echelon ciphers (generally groups of five numbers or letters). On the basis of the cryptanalyzed material an extensive card index was compiled on personnel and unit designations.

d. Final Evaluation

This operation was to be concerned with the top-level organization of the Soviet Armed Forces, Army, and Air Force.

As a result of the interception of air force ground communications detailed information was available on the structure and strength of the Soviet Air Force. Information was obtained, for example, about types of aircraft, armament, and equipment. With regard to the structure of the Army, however, the status of its reorganization, the distribution of its forces, and its preparations for border defense, the intelligence picture was quite incomplete.

Intercept coverage of Asiatic Russia produced rather meager results and the more distant parts of the armament production area could not be

~~CONFIDENTIAL~~
~~Security Information~~

OPERATIONS OF RADIO INTELLIGENCE IN SOUTHERN RUSSIA 1941-1942

- ← GERMAN OFFENSIVE THRUSTS
- ▨ GERMAN JUMP-OFF POSITIONS 21 JUNE 1941
- ▧ ASSEMBLY OF STRONG RUSSIAN FORCES AS REVEALED BY RADIO INTELLIGENCE

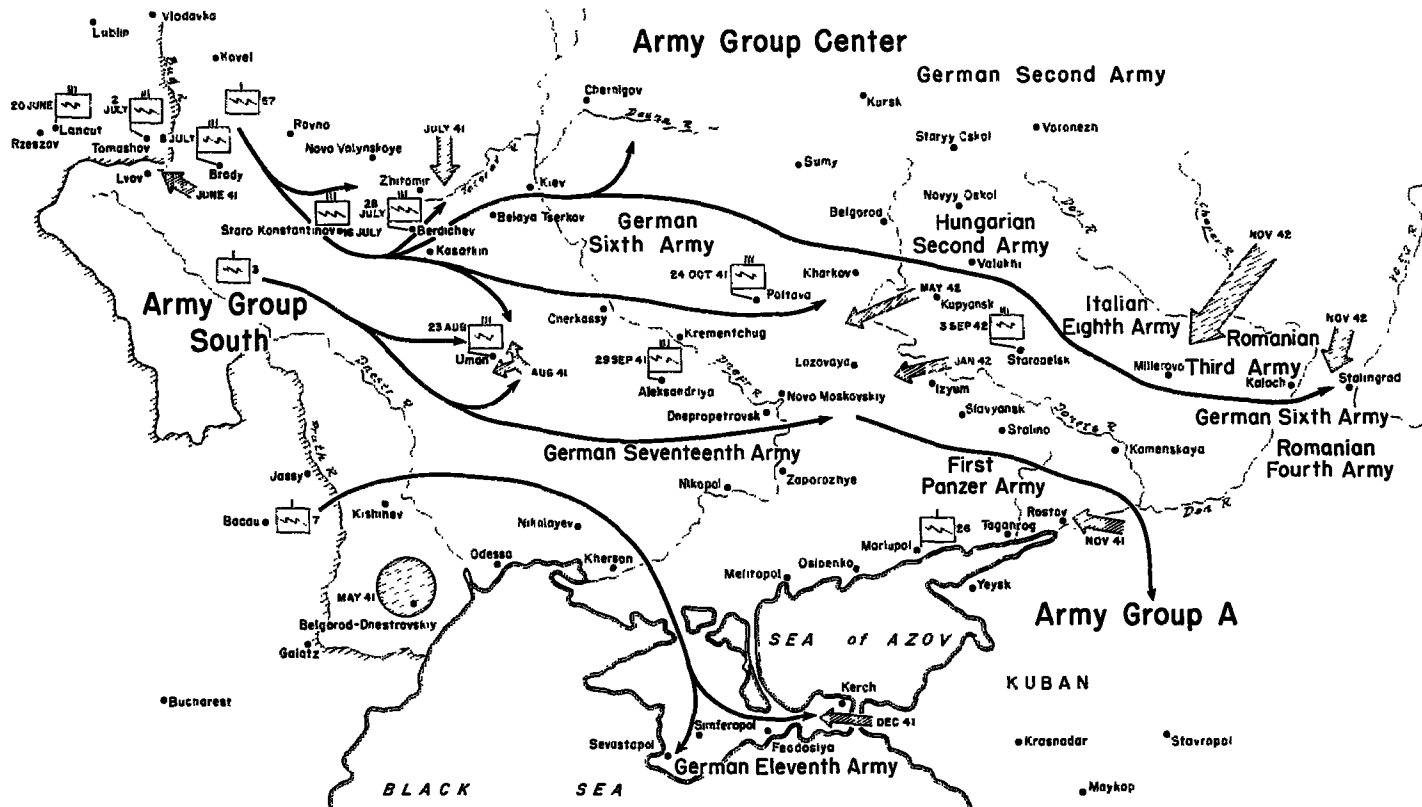

~~CONFIDENTIAL~~
~~Security Information~~

MS # P-038

-89-

covered at all.

The intercept equipment then available to the Germans was no match for the great distances involved. Lack of information about the Soviet border defense forces stemmed not only from the reduced volume of Russian radio traffic, made possible by extensive land lines, but to an even larger extent from the lack of short-range radio intelligence. Moreover, the German intercept units stationed near the western borders of the USSR from the Baltic to the Black Sea could not reach far into the interior of the Soviet Union. Long-range direction-finding operations with short-wave equipment were not effective until 1942.

The picture of the enemy situation based on radio intelligence differed substantially from information gathered from other sources. This was especially true of intelligence pertaining to the Soviet Air Force. Lack of information on the Soviet Army did not, however, lead German communication intelligence to make the dangerous mistake of underestimating the Russians' strength.

The following narrative refers exclusively to radio intelligence operations carried out in the area of Army Group South, commanded by Field Marshal von Rundstedt from June 1941 to November 1942. Because of the lack of records it is impossible to set down an exhaustive survey of this period. However, an estimate of Soviet Army radio traffic will be attempted by describing a few special missions undertaken by German radio intelligence on this front. In this connection it will be necessary to refer to the operations of the three intercept companies employed in this area. (See Chart 9)

~~CONFIDENTIAL~~
~~Security Information~~

MS # P-038

-90-

When the German invasion began, the following intercept units were operating in the area of Army Group South:

The 7th Intercept Company, on the Pruth, facing east, operating on a base line from Galatz to Jassy. Its mission was radio intelligence in the path of the Eleventh Army.

The 3d Intercept Company, on the eastern border of occupied Poland, facing southeast between Rzeszov and Vlodavka on the Bug. It was responsible for intelligence ahead of the Seventeenth and Sixth Armies.

The 57th Intercept Company was en route from the Balkans. It arrived in Rzesvoz on 28 June after the start of hostilities and first had to be reorganized and to become oriented to the intercepting of Russian radio traffic. Thus, it was not completely ready to go into operation until July. It was then ordered to carry out radio intelligence missions in the path of the Sixth Army, thus releasing the 3d Intercept Company to the Seventeenth army.

These companies had insufficient personnel and equipment for the task of covering the large areas assigned to those armies. The command responsible for these allocations had been informed of this discrepancy before the missions were assigned.

On 2 June 1941, therefore, Army Group South ordered intercept operations to be restricted to a zone of action bounded in the north by the Pripyat Marshes and extending as far east as the Dnepr River. This would include only that traffic emanating from the Odessa and Kiev military districts. For the time being OKH refrained from assigning any RI missions which were more far-reaching than this.

~~CONFIDENTIAL~~~~Security Information~~

MS # P-038

-91-

On 22 June 1941, immediately after the German Army had made contact with the Russians, the latter lifted all radio restrictions. The volume of messages rose so sharply that it was reasonable to conclude that the Russians had been taken completely by surprise, if not by the attack itself, then at least with respect to its timing. Long encrypted messages alternated with dispatches sent in the clear. These made it possible to sketch the rough outline of the radio picture, especially in front of the Seventeenth and Sixth Armies. The Germans could then draw conclusions -- though at first unreliable -- about the number of Russian divisions opposing them and could identify the numerical designations of corps and divisions. Since the Russians continued to use codes and ciphers which had already been broken, some of their messages could be cryptanalyzed at once. The more difficult systems did, however, provide sufficient text for new attempts at a solution, which were begun immediately.

The first German impression of Russian traffic was that, when suddenly surprised by a difficult situation, the enemy was unable to maintain adequate radio security, although this became even more necessary than before.

On the second day of hostilities, signals were intercepted whose points of origin were plotted east of Lvov. The interpretation of this radio activity was of great significance to the German command. At first, the signals consisted exclusively of emissions resulting from tuning adjustments. The Russians used frequencies outside the range of any radio set of which German signal intelligence had definite knowledge as of that time. The intercept team detailed to investigate these signals

~~CONFIDENTIAL~~~~Security Information~~

MS # P-038

-92-

picked up a number of poorly disguised designations, such as "TK" (tank korpus [sic]). The name of a certain lieutenant colonel of the armored forces was mentioned. In addition, brief check-calls were made by subordinate stations, all of which indicated the assembly of a mechanized force probably consisting of three divisional units, two of which were armored and appeared to be of the same type, judging from the characteristics of their radio traffic. This interpretation was adhered to, although it was doubted by the German command, which considered it improbable that mixed motorized rifle and tank brigades hitherto recognized had been reorganized so suddenly into regular-type armored divisions and were coupled with a motorized rifle division to form a triangular corps. The interpretation suggested by radio intelligence was confirmed, however, in the course of the engagements that commenced in the Lvov area immediately after this information had been intercepted.

In the course of the campaign Russian tank units frequently gave themselves away by faulty radio communication before beginning to attack. German intercept personnel pounced on the especially careless requests for fuel which were radioed by Soviet tank units. Not until the middle of 1942 did the Germans find it more difficult to intercept them.

In the path of the Eleventh Army the presence and intentions of a strong enemy force assembled near Belgorod-Dnestrovskiy in southern Bessarabia were accurately reported, a success which, in this case, was due exclusively to effective cryptanalysis.

The newly-arrived 57th Intercept Company quickly changed over from observing Yugoslav and Greek traffic to the interception of Russian com-

~~CONFIDENTIAL~~
Security Information

MS # P-038

-93-

munications. Its mission was to observe the Russian defensive build-up west of Kiev in July 1941. Chiefly by means of direction finding it followed the gradual withdrawal of these forces across the Dnepr. Then, for the first time, it became impossible to solve messages handled by corps and division nets, because the enemy had finally changed all his cryptographic systems.

By concentrating both intercept companies in the Kasatkin-Belaya Tserkov-Uman area in the path of the German Seventeenth and Sixth Armies, the strength of the Russian Twelfth Army in particular was revealed by its radio communications as well as by the direction-finding operations focussed on it. There was an especially high yield of clear-text messages during the battle of the Uman pocket in mid-August 1941. The utter confusion on the part of the Russian radio nets, which was reminiscent of the traffic intercepted at the end of the Campaign in the West, spelled an impending collapse.

Captured documents not only confirmed the results obtained by radio intelligence evaluations but also provided valuable supplementary information for traffic analysis and message evaluation procedures. Captured radio equipment provided additional information about the frequencies used by the Russians, and the cryptographic material which had fallen into German hands facilitated the work of the intercept control center in solving the difficult Russian codes. Quite revealing was the interrogation of Colonel Karmin, the captured commander of signal troops of the Russian Twelfth Army. The RI results obtained during the two months prior to his capture, which were discussed with him, indicated that Russian radio traffic

~~CONFIDENTIAL~~
Security Information

~~CONFIDENTIAL~~
~~Security Information~~

MS # P-038

-94-

was very vulnerable to German interception because of its rigid operating procedure, the failure to change call signs and frequencies at frequent irregular intervals, and, especially, the gradual deterioration of their radio discipline. A previously-made observation was confirmed, namely, that the not too intelligent Russian radio operators at division level and below could handle only simple ciphers. On the other hand, the complicated systems used by the intermediate and high command echelons, which were handled by special cryptographic staff officers, were reasonably secure. In spite of this, German strategic long-range radio intelligence was successful, because it devoted more attention to traffic analysis when message evaluation failed to produce results. On the other hand, the Germans rarely used tactical short-range intelligence, for which there is generally little occasion during rapid advance movements.

When the Germans captured Kiev, the Russians surprised them by the use of radio-controlled mines, which were actuated by tone-modulated carrier waves. The intercept personnel, being fully occupied with their regular intelligence missions, did not recognize these impulse transmissions. They were first identified by radio operators of the German Sixth Army. A special intercept platoon was attached to that army to observe these signals, so that means might be devised for jamming the frequencies used. Jamming transmitters were taken from the corps signal battalions and turned over to the special intercept platoon. After many days of unsuccessful attempts they finally succeeded in neutralizing the detonating impulses. The discovery of these impulse emissions led to the suggestion that a special unit be organized to intercept them in order to protect the troops against this

~~CONFIDENTIAL~~
~~Security Information~~

~~CONFIDENTIAL~~~~Security Information~~

MS # P-038

-95-

kind of weapon. OKH was unable, however, to adopt this suggestion because of the shortage of intercept personnel and equipment.

After reaching the Dnepr the three intercept companies were stationed side by side along the base lines Kiev - Cherkassy, Cherkassy - Dnepropetrovsk, and Dnepropetrovsk - Nikolayev; advance intercept stations were moved up to the bridgeheads at Kiev, Kremenchug, and Zaporozhye. On 15 September 1941 the army group assigned these units a new intelligence mission, which comprised the area embraced by the line Kiev - Voronezh - Rostov - Kherson with the main effort directed at the Donets Basin. Included also were the Crimea and the Kuban area on the southern flank. It was urgently necessary to find out whether and how the enemy was organizing his defenses east of the Dnepr, whether reserves were being brought up, and what changes had taken place in the command structure. Moreover, the radio traffic of the Black Sea fleet was to be observed. OKH supplemented this mission by ordering very-long-range intelligence operations against the western and southern regions of the Caucasus adjacent to Turkey and Iran. Certain newspaper accounts stated that, between late August and mid-October, OKH had clearly recognized the administrative nets of four Soviet armies which were in the process of activation in the area east of Moscow. Those reports appear to have been exaggerated. In any case, findings such as these were not brought to the attention of Army Group South at that time.

Then on 2 October 1941, the German attack from the Dnepr bridgeheads was resumed, the Sixth Army was advancing toward Kharkov, the Seventeenth Army was moving in the direction of the Donets Basin, and the Eleventh

~~CONFIDENTIAL~~~~Security Information~~

~~CONFIDENTIAL~~
~~Security Information~~

MS # P-038

-96-

Army was turning southward from the Lower Dnepr toward the Crimea. At the same time Panzergruppe Kleist -- later the First Panzer Army -- was advancing on Rostov. All the while, the area under intercept observation became so much larger that the 7th Intercept Company had to be reinforced and divided into three units so that it could cover the Crimea and the Donets area, as well as carry out the OKH order for very-long-range reconnaissance. This measure was an emergency solution characterized by all the deficiencies inherent in improvisation. The Army Group South area could no longer be covered adequately. The Army Group's request that a fourth intercept company be assigned to the First Panzer Army was not granted.

As a result of the new intercept operations, which had been initiated from the west bank of the Dnepr, the impression soon arose that the enemy radio traffic was becoming steadier, a symptom which obviously pointed to a reorganization, and presumably to a stiffening of Soviet resistance. The chief characteristics of the apparent reorganization were the absence of any corps headquarters, as suggested by the direct radio links between army and division headquarters, and appearance of "fronts," which corresponded to the German army groups.

During October 1941 the Sixth and Seventeenth Armies and the First Panzer Army reached the Donets and the Mius and took Kharkov and Rostov. For the purpose of covering the extensive Kharkov area, where the most stubborn resistance was encountered, the 57th Intercept Company was retained at army group headquarters in Poltava and its D/F teams were assigned the area between Lozovaya and Sumy. The 3d Intercept Company was moved up to

~~CONFIDENTIAL~~
~~Security Information~~

~~CONFIDENTIAL~~
~~Security Information~~

MS # P-038

-97-

Slavyansk, where it carried out its direction-finding operations on a line from Mariupol on the Sea of Azov to a point west of Izjum on the Donets. Coverage of the enemy area as far east as the Don between Voronezh and Rostov was thus reasonably assured. The 7th Intercept Company, operating with the Eleventh Army against the Crimea on the base line Kherson - Osipenko (subsequently Simferopol - Osipenko), continued to assist in observing the Rostov area, insofar as its mission against the Crimea and the Kuban area permitted.

During the German advance from the Dnepr to the Donets a reliable picture of the composition of the Soviet forces on the forward part of the army group front was produced from an evaluation of the Soviet radio traffic, which had once again been revived.

The Russians now began to limit their radio activity to that of the advance command nets. In order not to lose contact with further developments, and in the expectation that Soviet radio operators would not maintain their customary discipline, the German divisions were emphatically instructed to intensify the activity of their short-range intelligence platoons. The 3d Intercept Company stationed in Slavyansk was ordered to employ all personnel who could possibly be spared from long-range intelligence operations for use in tactical short-range intelligence. For all practical purposes this company took over the direction of short-range radio intelligence in co-operation with the short-range intelligence platoons of the divisions on the Donets front. The German intelligence analysts now built up the enemy radio picture from front to rear, instead of from rear to front, as formerly. After the translator problem had been

~~CONFIDENTIAL~~
~~Security Information~~

~~CONFIDENTIAL~~
~~Security Information~~

MS # P-038

-98-

more or less solved, this unusual procedure brought good results, since far-reaching conclusions could be drawn from the generally insecure phone traffic of the Russians.

Up to the middle of November 1941 there were two distinct focal points against which the 57th Intercept Company was ordered to direct its long-range intelligence operations, namely the area embraced by the line Kharkov - Belgorod - Valukhi - Izyum, as well as that east and southeast of Rostov. Whereas it was impossible at first to obtain any reliable information about the former area, radio nets were recognized in the latter area which, being tightly organized, enabled the Germans to ascertain the assembly of several divisions. The radio picture thus gained, however, did not correspond in any way with reports from other sources, according to which only weak forces were stationed near Rostov, which even the enemy contemptuously referred to as a golaye armiya (stripped army). It seemed peculiar that cryptanalyzed intercepts should mention the numbers of divisions which had been destroyed in the previous fighting. Their reactivation under previous designations was doubted by the German command until it was confirmed in combat.

About the same time, the sky wave emissions of a radio net operating on the short wavelengths were picked up. This net apparently did not maintain close contact with military headquarters but seemed to operate essentially between armament factories. Its clear-text messages mentioned division designations in the 400 series and above of which there was no previous record. At first, OKH considered this a Russian deception, since it believed that such large-scale activations were unlikely, reckoning

~~CONFIDENTIAL~~
~~Security Information~~

~~CONFIDENTIAL~~~~—Security Information—~~

MS # P-038

-99-

on the assumption that from every million population one could form but two divisions at full wartime strength. Since European Russia had a population of some 160 million and Asiatic Russia, about 30 million, no more than 380 divisions, therefore, could be activated. Some 330 divisions (260 rifle and motorized rifle, 50 tank, and 20 cavalry divisions) had already been engaged by the Germans. It could be assumed that there were 40 divisions behind the front and 20 divisions in the Far East and Caucasus. However, the existence of divisions bearing designations in the 400 series was actually confirmed later in the campaign.

In late November 1941, traffic in the Rostov net indicated that there were ten stations in the net. Even though one could not be sure that ten full divisions were involved, since some of the intra-net relationships were not at all clear, it was nevertheless evident that a troop concentration was under way such as had not been seen for quite some time on the Eastern Front. It was, therefore, reasonable to conclude that a Russian attack was imminent. At the same time new traffic was heard from the vicinity of Yeysk on the Sea of Azov. However, after careful surveillance, this traffic was interpreted as a deception measure because of its incoherence. On 28 November 1941 the Russians attacked Rostov, after Army Group South had ordered its evacuation and the withdrawal behind the Mius of the southern wing of the First Panzer Army.

Because of the great distances, ranging from 500 to 600 miles, radio intelligence against Transcaucasia and the Black Sea fleet failed to produce satisfactory results. In any case, the interception of short-wave training transmissions from the Tiflis military district

~~CONFIDENTIAL~~~~—Security Information—~~

MS # P-038

-100-

revealed the presence of additional reserves in this area. Moreover, army staffs were detected in both Tiflis and Kutais. On the other hand, coverage of allied traffic originating in or near Iranian territory was incomplete. Coverage of British traffic originating in Iran was especially fragmentary.

It was impossible to detect in time the Russian preparations for an attack on the eastern Crimea, which was carried out in conjunction with a landing in Feodosiya.

At the end of the first year of the war it was clear that the Russians had made progress in their transmission security and had begun to correct the defects which had developed during the first engagements.

In January 1942 OKH ordered the commanders of intercept units attached to army groups to effect deceptive measures by commencing large-scale radio transmission along the entire front. However, before results could be expected, the enemy attacked south of Kharkov, between Slavyansk and Balakleya. Here, in contrast to the situation around Rostov, German radio intelligence could not predict the Russian attack because of its failure to detect the assembly of enemy forces. Heavier Russian radio traffic during the penetration which the Germans halted near Lozovaya once again supplied the intercept service with the material necessary to the fulfilment of its mission, despite the fact that the 3d Intercept Company committed near Slavyansk had been inoperative for a fairly long period of time. Since this company had to be utilized as a combat unit, it was forced to discontinue its intercept operations. As soon as the immediate danger was over, the company was pulled back to Stalino, where it resumed its intercept operations.

~~CONFIDENTIAL~~~~Security Information~~

MS # P-038

-101-

Immediately after the enemy penetration was sealed off, Russian radio traffic decreased and was characterized by the same high degree of security which prevailed before the attack. However, the Germans noticed with surprise that this activity was restricted to the general area around Kharkov. Consequently, the short-range intelligence units were once more brought to maximum strength within the means available. The belated reorganization of the German intercept service into separate long-range and short-range RI units -- the latter by assembling the short-range intelligence platoons of the divisions into companies which were subordinate to the communication intelligence commanders at army group headquarters -- gradually got under way. By performing a laborious and piecemeal job the German intercept units eventually succeeded in plotting three enemy forces north and south of Kharkov: near Voltschansk, ten to fifteen rifle divisions, three cavalry divisions, and five tank brigades; in the Lozovaya - Balakleya area, ten rifle divisions, more than five cavalry divisions, and at least ten tank brigades, presumably under the command of General Koniev; near Slavyansk, five additional mechanized units, apparently reserves, whose individual strength could not be ascertained. In view of the disproportionately large number of mobile forces consisting of tank brigades and cavalry divisions, a new Russian attack on both sides of Kharkov was to be expected. No clues were available for predicting the timing of the attack or whether its objective was to be limited in scope. Throughout this period the Russians maintained relatively strict radio discipline. This may be said of the Russian attack east of Voltshansk, the attack from the Izyum salient south of Kharkov, which commenced on 12 May 1942, the German counterattacks from the Slavyansk - Barvinovka

~~CONFIDENTIAL~~~~Security Information~~

MS # P-038

-102-

line northward to Balakleya, during which enemy forces west of the Donets were encircled and destroyed, and the elimination of the Russian penetration near Voltshansk.

Russian radio traffic during the final stage of the fighting in the Crimea was far less disciplined. After the Germans had occupied the peninsula with the exception of Sevastopol, which was no longer of interest from a long-range intelligence point of view, the 7th Intercept Company was moved north in early June 1942 in order to increase the coverage of the Kharkov area. Abandoning its long and medium-wave direction-finding operations for the time being, the company was employed for intercept purposes only, after experiments had shown that reception of short-wave signals from the Kuban and Caucasus areas was more favorable, or at least of equal quality, at a greater distance from the objective. The 3d Intercept Company stationed at Stalino was given the task of covering the area east of the lower Don.

Radio intelligence produced hardly any results during the German attack across the Donets in July 1942, the objective of which was to reach the Don between Rostov and Voronezh. The Russian divisions appeared to be withdrawing, during the course of which movement radio silence was maintained. At that time it was not even possible to identify the stations in the higher-echelon command net, the observation of which had hitherto always yielded good results. Russian radio traffic on the northern Don front seemed to be under the supervision of a particularly capable individual.

~~CONFIDENTIAL~~
Security Information

MS # P-036

-103-

The Sixth Army was making preparations for an offensive against the corridor between the Don and Volga in the direction of Stalingrad, while the Seventeenth Army was pulled out of the front and assigned to the newly arrived headquarters of Army Group A under Field Marshal List. This army group was supposed to seize the Caucasus. That zone of the Don front which had previously been held by the Seventeenth Army was taken over by the Hungarian Second Army in the north, the Italian Eighth Army in the center, and the Romanian Third Army in the south. The three last-mentioned armies had weak long-range RI units, whose efficiency varied. The Hungarians were capable of performing limited independent missions, whereas the Romanians could not be entrusted with any such missions.

The Romanian Fourth Army adjacent to the right wing of the German Sixth Army had no communication intelligence unit whatever. The Hungarians, Italians, and Romanians were unfamiliar with short-range operations and lacked any understanding of inter-army co-operation in the pursuit of radio intelligence missions. The Italians were inclined to theorize about radio intelligence results instead of subjecting them to careful analysis. Characteristic of their methods was the fact that they made it a practice to use Russian prisoners of war as radio intercept operators.

To achieve greater security the 57th Long-Range RI Company was stationed behind the Hungarian and Italian Armies in Novyy Oskol, with a D/F base line along the upper Don. The 3d Long-Range RI Company was moved up to the vicinity of Kamenskaya and ordered to cover the area in the path of the German Sixth and the Romanian Fourth and Third Armies. The 7th Long-Range RI Company was moved close to the new headquarters of

~~CONFIDENTIAL~~
Security Information

~~CONFIDENTIAL~~
~~Security Information~~

MS # P-038

-104-

Army Group South in Starobelsk. Its mission was to cover either the northern or the southern zone of advance, according to how the enemy radio picture developed. As the result of repeated requests, the 26th Long-Range RI Company, which had so far been held at the disposal of OKH, finally arrived at Mariupol and Taganrog, from where it was to cover the Kuban and Caucasus areas exclusively. The newly-organized short-range companies were committed in the Sixth Army sector.

The new mission was in accordance with the orders issued in July and August 1942 by the two army group headquarters, which did not limit the depth of the intercept area. As soon as Army Group A assumed command in the south, the Commander of Communication Intelligence (six) was to take charge of the 3d and 26th Long-Range Companies, as well as of the short-range RI company of the Seventeenth Army.

During August the solution of a large number of the Soviet cryptographic systems enabled the Germans to plot the disposition of the Russian divisions defending the east bank of the Don between the mouth of the Khoper and Voronezh. By mid-September, chiefly through short-range intelligence results, the Germans were aware of the disposition of Russian forces on the newly-formed Stalingrad front along the Don - Volga Corridor. After reaching Stalingrad the Germans were familiar with most of the Soviet divisions defending the east bank of the Volga. In view of past experience, such comprehensive results had not been expected. The explanation for this was given by a Russian radio message, which stated that the radio restrictions which the enemy had intended to impose could not be maintained because of the shortage of wire communication facilities.

~~CONFIDENTIAL~~
~~Security Information~~

~~CONFIDENTIAL~~
~~Security Information~~

MS # P-038

-105-

For the same reason, the Russians seemed to be compelled to transmit estimates of the enemy situation by radio. These estimates indicated that they had accurately gauged the weakness of the Romanian and Italian Armies and the vulnerability of the boundaries between them.

In October 1942 the Germans uncovered the formation of a strong Russian force on both banks of the Koper. According to a garbled intercept, the far-reaching strategic objective of this force was Rostov. On 19 November the Russians began to attack across the Don.

Equally timely was the interpretation from traffic analysis of the movements which, ⁱⁿ mid-November, led to the encirclement of the German Sixth Army. At that time the communication intelligence commander submitted a detailed report summarizing his observations to army group headquarters, where it was approved and forwarded via OKH to OKW. The contents of this report revealed the threatening development in all its ramifications. The report, which was lost at the end of the war, attributed the deterioration of Russian radio security primarily to their growing feeling of absolute superiority.

From the beginning of the Russian campaign until the reverse at Stalingrad in 1942-43, German radio intelligence operations against Russian communications was carried out under the most difficult circumstances. As already mentioned, the personnel and equipment available were entirely disproportionate to the magnitude of the intercept mission. It was impossible to cover the target area either in depth with barely a hundred receivers, or laterally with three long-medium wave D/F base lines and one short-wave long-range D/F base line. Inadequate intercept communi-

~~CONFIDENTIAL~~
~~Security Information~~

MS # P-038

-106-

cation facilities, which were not improved until late 1942 when the communication intelligence commanders were supplied with their own circuits, made it difficult to co-ordinate intelligence activities and to exchange solutions among individual units. The vastness of European Russia, the indescribably difficult terrain conditions, especially after the beginning of the muddy season (rasputitza), and finally the unusually low temperatures, which occasionally halted the work of the D/F teams, interfered with the efficiency of operations. If the Germans were able to obtain comprehensive results, this is to be attributed to systematic coverage which always emphasized selection of only the most important targets and security. to the relatively low level of Russian transmission/ In view of the vastness of their country and the inadequacy of their land lines, the Russians, more than any other nation, were forced to rely on radio communication. Logically, this fact should have induced them to be especially painstaking in maintaining security. They attempted to achieve security exclusively by safeguarding the cryptosystems used in their higher-echelon traffic, some of which were solved despite the fact that they caused considerable difficulties. On the other hand, the Russians neglected to make their field ciphers equally foolproof against cryptanalysis. This was the reason why the German intercept service could continue to produce results during the Kharkov operations when the results obtained from observing Russian command nets fell to a very low level. In this connection it should be remembered that because of its many dialects, the Russian language imparts a degree of security to clear-text messages which only outstanding translators can overcome. Such translation experts are equally indispensable

~~CONFIDENTIAL~~~~Security Information~~

MS # P-038

-107-

for successful cryptanalysis, for which a complete command of the language is an absolute requisite. The evolution of Russian radio traffic during the period under review proves that the military leadership was endeavoring to improve the security of its radio communication. This was accomplished chiefly by imposing radio silence or at least by restricting the use of radio communication. Actually, these orders were rarely obeyed in a consistent manner. It is in keeping with the mentality of the Russians that they are more successful in restraining the urge to indulge in unnecessary chatter during troop concentrations and assemblies, defensive actions, and withdrawals than during attacks which promise success, and during advances. Their ability to use electrical and mechanical devices to attain a high degree of transmission security should not be underestimated. However, it required quite some time before the Russian field radio operators become adjusted to such complicated innovations.

A certain awkwardness characterized Russian radio operations and will probably be difficult for them to overcome. It is precisely this awkwardness which constitutes the greatest danger to the secrecy of wartime radio communications. For this reason the interception of Russian radio communications will probably always be rewarding.

- - - - -

The Russians were very much aware of the potential effectiveness of enemy radio intelligence. This was evident from the numerous intercepted conversations in which the parties, probably fearing that violations would be overheard and reported for administrative action, called each other's attention to security regulations or when one party broke

~~CONFIDENTIAL~~~~Security Information~~

~~CONFIDENTIAL~~
~~Security Information~~

MS # P-038

-108-

off the conversation because of such violations at the other end.

While serving as commissar with Budenny's cavalry army in 1920, Generalissimo Stalin observed the defects of the Russian radio service. It was he who is supposed to have given impetus to its improvement and to have subsequently insisted upon the necessity of strict radio discipline. The work of German radio intelligence grew even more complicated by virtue of two drastic changes in the Russian radio service during World War II. The first change occurred as early as 1 April 1942, when Army Group Center was suddenly confronted with entirely new cryptosystems and call signs, and noticed that the authentication groups which had hitherto facilitated our traffic analysis had been discontinued. This was probably because the methods then employed by German radio intelligence and the "entering wedges" spotted by the cryptanalysts had been betrayed by a deserter from an intercept unit. The changes brought about by this incident led to a setback in German intelligence results lasting several weeks. The next crisis in German communication intelligence followed the loss of Stalingrad, when the Russians captured intercept files. At that time the Germans intercepted Russian instructions concerning the restriction and supervision of radio traffic. It was surprising, however, that in spite of these stringent orders, prohibitions, and threatened penalties, and the strict, autocratic nature of the Russian command, numerous army units and many non-military organizations nevertheless did violate the rules.

This deviation from strict adherence to regulations was one of the most vulnerable points in the Russian radio service, and provided German

~~CONFIDENTIAL~~
~~Security Information~~

~~CONFIDENTIAL~~
~~Security Information~~

MS # P-038

-109-

long-range intelligence with reliable information along the entire front, even after the above-mentioned changes in procedure. The higher-echelon headquarters that were engaged in strategic missions, especially the tank army headquarters, observed radio silence before launching an operation, or else confined their transmissions to brief test calls, so that little useful information could be obtained from them. It was different in the case of the GHQ troops assigned to these headquarters to provide an additional boost. They exchanged lively radio traffic, not so much because of lack of discipline as for administrative and supply reasons arising from their dispersal over wide areas. They did not use the complicated cryptosystems of their superior headquarters, but easily-broken field ciphers, with the result that their carelessness nullified the precautions taken by the higher echelons.

This applied equally to the artillery divisions and artillery corps. In many instances the Germans were able to learn of plans which the higher echelon headquarters was extremely careful to keep secret by intercepting messages from such units as formations of the assault specialist, Sokolovski, and the heavy mortar, rocket launcher, and army engineer forces. In general, it was possible to obtain a fairly accurate picture of the number of armies and divisions, their location and boundaries, the arrival of reinforcement and the displacement of units, and thus the concentration of forces by observing and plotting the GHQ artillery, heavy mortar, and rocket launcher units. A captured Russian signal officer explained that this carelessness in radio operations was due to the shortages of telephone cables and field phones and the distances to be covered.

~~CONFIDENTIAL~~
~~Security Information~~

~~CONFIDENTIAL~~~~Security Information~~

KS # P-038

-110-

The heavy mortar and rocket launcher units always carried on a very lively radio exchange. Wherever they appeared the Germans knew that a Russian attack was under preparation. The presence of army engineer units was often the first indication of an impending armored offensive, before which they sent progress reports on the construction of roads, the building and reinforcement of bridges, and the clearance of lanes through the mine fields.

Additional clues to the preparation of offensive operations were furnished by messages from and to supply and service troops. When German intercept units uncovered the first two major nets of this type, Hitler erroneously interpreted them as a Russian radio deception maneuver, although radio intelligence found no reason to substantiate this opinion. In October and November 1941 a conspicuous net was observed in the vicinity of Vladimir, 120 miles east of Moscow, and another one east of Rostov. Their messages dealt with the equipment and training of numerous newly-organized formations. The "Vladimir net" was believed to represent four armies; the Rostov net, ten divisions. Radio intelligence was vindicated by the counterattacks carried out by these forces in late November and early December against Rostov and in the Moscow area, where the Germans suffered disastrous setbacks.

Intercepts indicating the location of ammunition, fuel, and ration dumps provided reliable information used in the planning of German air attacks. The greater the strain in the Russians' supply situation, the more intensive was the radio traffic. The Germans were thus able to draw pertinent conclusions concerning the tactical situation of the enemy forces.

~~CONFIDENTIAL~~~~Security Information~~

~~CONFIDENTIAL~~~~Security Information~~

MS # P-038

-111-

In front of Stalingrad toward the end of 1942 and the beginning of 1943 the Germans succeeded in intercepting messages from Volga steam ferries indicating the number of their nightly crossings which required six hours whenever ice jams were present. Other messages conveyed an impressive picture of the shipments of infantry, artillery, guns, tanks, horses, vehicles, ammunition, and miscellaneous supplies which were moved across the river. Since the daily strength reports of the Russian units in action were currently intercepted, it was possible to establish that only a very few of the reinforcements and supplies were intended for the decimated troops engaged in the fighting. The obvious conclusion was that the enemy was moving up entire divisions which he did not intend to commit until the beginning of a major offensive.

In some instances the Germans were able to follow movements by rail of newly-organized divisions from the interior of Russia up to the front, first by plotting their location through D/F procedures, then by picking up their trail as soon as they established contact with the headquarters to which they were assigned.

The following is an example of German radio intelligence operations at army level. In December 1943 ground and air reconnaissance north of Vitebsk failed to produce any significant information. On the other hand, traffic analysis, D/F plotting, and cryptanalysis of the transmissions of the radio nets operated by Russian engineer, heavy mortar, rocket launcher, artillery, and service units provided an almost complete picture of the Third and Fourth Main Assault Armies on both sides of the Eleventh Guard Army. These forces were facing the German Third Panzer Army in the

~~CONFIDENTIAL~~~~Security Information~~

~~CONFIDENTIAL~~
~~Security Information~~

IS # P-038

-112-

Gorodok - Yezerishchi area. Radio intelligence furnished the usual profusion of details about division boundaries, the location and stock level of ammunition dumps, and the exact co-ordinates of tank-supporting bridges, lanes through mine fields, and field emplacements. At approximately H minus 10 hours radio intelligence established that the attack was imminent by observing that the Russian army command posts had been advanced up to two miles behind the MLR.

The Germans obtained accurate information on the enemy's strategic objectives by observing the radio traffic of the air force ground installations. These units appeared regularly in the center of the fighting or wherever points of main effort were to be formed. Here they had to lay out air strips, stake off suitable terrain, build shelters, and prepare runways which were then used by airlift or close-support formations.

Valuable clues concerning the strategic and tactical plans of the Russian command could frequently be drawn from the instructions issued to partisan units, so-called strategic reconnaissance groups, and spy teams, as will be explained in greater detail in the following chapter.

The interception of messages from NKVD units was extremely fruitful. The latter maintained their own radio net extending to the smallest unit and used their own exclusive cryptosystems. Regular and systematic coverage permitted the Germans to draw conclusions regarding the composition, organizational structure, and employment of the NKVD units. According to these observations there were two blocking lines, the first one at a distance of about six to ten miles, the second one at about thirty to forty miles behind the Russian front. These two lines sealed off hermetically

~~CONFIDENTIAL~~
~~Security Information~~

~~CONFIDENTIAL~~~~Security Information~~

MS # P-038

-113-

the rear areas from the zone of interior. Along many sectors of the front NKVD operations could be regularly observed down to the individual guard posts, sentry squads, and control points of the first blocking line. Although the proportions of the individual sectors under jurisdiction of the NKVD units did not exactly correspond to the boundaries and width of sectors held by army units at the front, there existed a certain interrelationship. Moreover, the NKVD failed to observe the radio silence imposed by higher-echelon headquarters. They were far less security conscious than these headquarters, probably because of the distance separating them from the front and the lack of proper supervision. The radio messages to and from the various check points often contained requests for apprehension including the names of individuals and their troop units, reports on the arrival or departure of officers -- including generals -- and on routine checks of travel orders, and similar matters which furnished important information about units committed at the front or stationed in rear areas.

From conspicuous organizational changes and the arrival of new NKVD units the Germans were able to draw conclusions as to the scope of impending operations. Up to the very end of the war a great number of the NKVD cryptosystems were solved by the Germans.

The characteristics of Russian radio operations made it impossible to draw a sharp line between short-range and long-range operations. As of 1943, when these two phases of intelligence activity were complementing each other successfully, three factors should be mentioned that facilitated the German radio intelligence effort:

~~CONFIDENTIAL~~~~Security Information~~

~~CONFIDENTIAL~~
~~Security Information~~

MS # P-03E

-114-

1. The Russians' adherence to established procedures in sending routine messages and in carrying on conversations.
2. As on other fronts, the **idiosyncrasies** of Russian radio operators who were less self-disciplined, intelligent, or well-trained than the average enabled the Germans to identify and observe entire divisions. Among many others their deviations from rules of procedure included variations in sending speed especially in beginning and closing a transmission, arbitrary modifications of call signs to facilitate quick recognition by the called station, peculiarities in tuning the transmitter, and mistakes in transmitting unusual signals. Technical defects, such as a chirp, also made it easy to trace a particular station.
3. Last, but not least, the Germans benefited from the fact that the steadily increasing number of Russian radio stations, for which American Lend-Lease supplied much equipment, furnished an almost inexhaustible wealth of information. The restrictions on radio traffic imposed by orders from above were apparently not implemented.

A few units, such as the II Guard Armored Corps, observed strict radio discipline, for which an energetic commander and a security-conscious signal officer were apparently responsible. They complicated the task of German communication intelligence. In general, however, the radio discipline standards of most front-line units was low. On the other hand, one must acknowledge that until the very day of the German capitulation the Russians never indulged in the complete relaxation of all rules and undisciplined clear-text transmission of radio messages which was practiced

~~CONFIDENTIAL~~
~~Security Information~~

~~CONFIDENTIAL~~~~Security Information~~

MS # P-038

-115-

by the Western Allies in anticipation of an early victory.

The following figures will convey an idea of the number of radio stations operated by the Russians at the end of 1943. Before a major offensive along the twenty-five-mile sector held by the Third Panzer Army, German radio intelligence observed 300 enemy radio stations.

Various areas of the Soviet radio system were characterized by the above-mentioned rigid adherence to established procedure which facilitated the German radio intelligence effort. For instance, several code designations used in both CW and phone communication remained unchanged for years along the entire Russian front: "manager," stood for chief of staff, "pickle," for ammunition, "box," for tank, "shop," for unit. Battalions were designated by species of trees, such as pine, oak, or beech; companies were referred to by trades, such as shoemaker, tailor, or baker; and platoons were given names of animals, such as horse, cow, or sheep.

For years, call signs and frequencies were changed on the 1st, 10th, and 20th of each month; cryptosystems, every one to three months. A period of radio silence preceded each major offensive during which entirely new cryptosystems would be used. However, because of the previously-mentioned operating characteristics, the Germans had no difficulty in resuming interception of previously-known units. The routine daily reports, sent according to a fixed schedule, provided a particularly rich fund of reliable information. During the battle for Stalingrad at the end of 1942, German radio intelligence was able to set up a systematic body of statistics on the Russian tank strength by entering the inter-

~~CONFIDENTIAL~~~~Security Information~~

~~CONFIDENTIAL~~
~~Security Information~~

MS # P-038

-116-

cepted figures under the following fourteen headings which were always transmitted in the same sequence in such form-type reports:

- Heading 1: T/E allowance of tanks
- " 2: Actual number of serviceable tanks
 - " 3: Total losses through enemy action
 - " 4: Permanent losses through enemy action
 - " 5: Total losses through wear and tear
 - " 6: Permanent losses through wear and tear
 - " 7: Number of unserviceable tanks on hand
 - " 8: Number of tanks reparable by organizational maintenance
 - " 9: Number of tanks reparable by field and depot maintenance
 - " 10: Number of tanks requiring repairs in the ZI
 - " 11: Number of irreparable tanks
 - " 12: Number of tanks received from organizational maintenance
 - " 13: Number of tanks received from field and depot maintenance
 - " 14: Number of tanks received from the ZI.

The following routine report was sent in the same form over a period of two years. At first it was difficult to solve. This was achieved only as the result of inquiries made by the Russian net control station. Its solution provided accurate statistical data concerning officer and enlisted personnel strength, casualties, number of guns, ammunition and gasoline supplies, the chain of command, and the location of gun positions. The numerical code used in this routine report was as follows:

- Heading 1: 334 :: 334th Rocket Launcher Battalion
- " 2: 5 :: subordinate to Fifth Army

~~CONFIDENTIAL~~
~~Security Information~~

~~CONFIDENTIAL~~~~Security Information~~

MS / P-038

-117-

Heading 3: 202 :: committed in the 202d Infantry Division sector

" 4: 312/407 :: co-ordinates of the battalion command post

" 5: 318/414, 309/148 :: co-ordinates of the firing positions

" 6: 16 :: number of guns

" 7: 13/1144 :: 1144 rounds of TS 13 ammunition

" 8: 12.5 :: 12.5 tons of gasoline

" 9: 9/60/204 :: number of officers, noncommissioned officers,
and other enlisted men

" 10: 0/2/4 :: losses: 2 noncommissioned officers, 4 enlisted
men

" 11: 140 :: rounds of ammunition expended

" 12: One infantry platoon and self-propelled gun destroyed
(This part of the message in clear text)

After 1942 Russian phone traffic became increasingly important for German radio intelligence. Proper evaluation of it required the assistance of excellent translators and a fairly close proximity to the front. At a distance of approximately six to ten miles from the MLR, provided the reception was good, the evaluation of phone transmissions was easier than that of CW traffic. At the same time the interception of radio conversations in which brevity codes, code name indices and grid co-ordinate ciphers were used was continued. In general these conversations took place between tank and other mechanized units after the beginning of a major engagement. The cryptosystem used to encipher co-ordinates was as a rule quickly solved by comparing the co-ordinates with the intelligence officer's situation reports and by D/F operations. Once this had been achieved, all details of the enemy's intentions became clear soon after the beginning of

~~CONFIDENTIAL~~~~Security Information~~

~~CONFIDENTIAL~~
~~Security Information~~

MS # P-038

-118-

the attack, inasmuch as messages concerning the attack directions, daily objectives, the course of the front line, casualties, and enemy resistance were being currently intercepted.

Some of the tactical commanders carried on conversations without taking more than the above-mentioned insignificant security precautions. In April 1945, for example, the commander of the Second Guard Armored Army then located in the Wriezen area east of Berlin held conversations with his corps, brigade, and tank spearhead commanders and discussed the scope of their missions, the axis of advance, time schedules, flank protection, antiaircraft security, and the army's objective. The latter was to thrust north of Berlin up to a point north of Potsdam, where the army would link up with forces advancing south of Berlin. Radio intelligence was able to submit an accurate report eight hours before the attack began.

During lulls in the fighting the results of short-range interception were insignificant, particularly when the Germans faced disciplined infantry and artillery units which observed radio silence and used wire communication. The fact that an attack was pending could best be deduced from observation of an exchange of test signals (v's) at regular hourly intervals. Once an attack had started, even the infantry and artillery of front-line divisions began to engage in phone conversations, either using a brevity code or talking in the clear altogether. In contrast to these units, which were probably supervised quite strictly, there were others whose commanders conversed in the most undisciplined and uninhibited manner. They thus presented German radio intelligence with complete information on Russian plans, estimates of the situation, orders, and other data.

~~CONFIDENTIAL~~
~~Security Information~~

~~CONFIDENTIAL~~
Security Information

MS # P-038

-119-

Both the short-range units (employed above division level) and the RI teams attached to the German divisions in Russia had that experience. The following examples have been selected from among the thousands of instances in which Russian phone transmissions provided valuable information to German division commanders:

In January 1942 the RI team of the 2d Panzer Division intercepted a plain-text Russian order for a night attack on Alexandrovka, south of Rzhev (Army Group Center), at H minus 1 hour. The defenders were alerted, and the attack was repulsed with great losses to the Russians.

In July 1942 the German Ninth Army was mopping up the Russian pocket near Belyy, west of Rzhev. The RI team of the 2d Panzer Division intercepted a plain-text conversation on the subject of the intended breakout of the Soviet 82d Tank Brigade, during which all the axes of movement were mentioned. Thereupon the 2d Panzer Division quickly blocked the routes of escape with 88-mm guns, which destroyed numerous T34 tanks. The breakout was prevented and the rest of the brigade withdrew to the swamps in the north. The brigade's radio traffic was kept under observation, and a message requesting assistance in towing the tanks out of the swamps was intercepted. The areas indicated in these messages were combed out by German infantry, and the immobilized, but otherwise undamaged, T34 tanks were neutralized. Russian division staffs tried to reorganize the scattered troops in the pocket by ordering them via radio to assemble at precisely-designated collecting points. The 2d Panzer Division artillery took them under fire, the effect of which could once again be checked by intercepting the Russian transmissions.

~~CONFIDENTIAL~~
Security Information

~~CONFIDENTIAL~~
~~Security Information~~

MS # P-038

-120-

During the German withdrawal from Rostov to the Mius, in the winter of 1942-43, a Russian motorized corps broke through the German lines. The gap was closed and the enemy was trapped. Plain-text Russian dispatches reporting a shortage of gasoline were intercepted by the RI team of the 23d Panzer Division. "What am I supposed to do?" asked the commander of the pocket force. "Break out at the same point where you broke through," was the answer of superior headquarters behind the Russian front. All available German forces were placed in ambush at the former breakthrough point. Nobody got through, and the Russian unit was wiped out.

In March 1943 the German 129th Infantry Division -- then commanded by the author of this section of the study -- withdrew from the Volga near Rzhev to the Smolensk - Moscow highway near Yartsevo, during the course of the so-called Buffalo Movement of the Ninth Army. Every day the division's RI team reported the approach of enemy troops to the successive German delaying positions as well as the enemy's organization and strength, physical condition after exhausting night marches, intended rest periods, logistical problems, the Russians' estimate of the German situation, and their plans in general. In the light of this reliable first-hand information intercepted from enemy sources, the Germans were able to examine their dispositions, reinforce their units at crucial points, place their reserves at the right points, and, above all, concentrate their fire on the most vulnerable targets the enemy so carelessly revealed to them, and make the proper distribution of the available ammunition on a day-to-day basis.

~~CONFIDENTIAL~~
~~Security Information~~

~~CONFIDENTIAL~~
~~Security Information~~

MS # P-038

-121-

In February 1944 the 23d Panzer Division was given the mission of stopping heavy Russian attacks on Jassy. On that occasion some T34's broke through the German lines and concealed themselves in the close terrain. They sent such messages as "our tracks are broken" or "turret damaged," whereupon the German RI team inquired: "What is your location?" As soon as they indicated their location, the tanks were destroyed by the Germans.

The Germans occasionally attempted to get a reply from Russian stations and usually succeeded in their deception. However, they refrained from intruding in enemy nets handling routine traffic in order not to arouse the suspicion of the other party. Any such action would have compromised future intelligence results. It was a different matter, however, when, in the heat of combat, the enemy asked for assistance without getting any reply to his calls.

In September 1944, a Russian corps was in a precarious situation northeast of Grosswardein. The RI team of the 23d Panzer Division intercepted a poorly-encrypted message ordering a Russian-Romanian regimental combat team to attempt to break out along a certain road. Elements of the division thereupon prepared an ambush in the forest on both sides of the road and completely wiped out the breakout force.

Appendix 8 gives the full story of the intercepts made by the RI team of a German infantry division during the course of one day of attack.

Within the scope of this study it is not possible to give more than these few examples to show the important role played by communication intelligence in the direct conduct of battle. There were innumerable

~~CONFIDENTIAL~~
~~Security Information~~

~~CONFIDENTIAL~~
~~Security Information~~

MS # P-038

-122-

instances where the Russians jeopardized their military operations by the manner in which they conducted, their field radio communication inasmuch as the Germans had the means for appropriate countermeasures in this theater.

Along the entire Russian front the reports from communication intelligence were considered as information from reliable sources.

In the autumn of 1943 the author, then chief signal officer at the headquarters of Army Group Center, received every day intercepts of CW and voice transmissions from which it was clearly evident that in hundreds of instances German prisoners were being murdered within a short time after their capture. In each instance a Russian regimental or division staff officer complained that no prisoners had been turned over to headquarters and requested that at least one man should be spared from being shot or otherwise murdered so that he could be interrogated. A truly shocking picture of the Asiatic combat methods used by the Russians!

When in the autumn of 1943 German forces, encircled near Cherkassy, succeeded in breaking out of the pocket, their overjoyed commander carelessly told propaganda officials about the tremendous help he had received from communication intelligence both while in the pocket and when breaking out of it, inasmuch as he was able to direct movements and conduct operations on the basis of intercepted Russian orders. Although this statement was publicized in the press and radio in the same imprudent manner, it did not have the disastrous consequences which had been feared for a time. Up to the end of the war the intercepts made by the RI teams on the Russian front remained an important source of information for the tactical commanders.

~~CONFIDENTIAL~~
~~Security Information~~

~~CONFIDENTIAL~~
~~Security Information~~

MS # P-038

-123-

Strategic radio intelligence directed against the Russian war production effort provided a wealth of information for the evaluation of Russia's military potential. Owing to the general dearth of long-distance telephone and teletype land circuits, radio communication assumed an especially important role in Russia not only as an instrument of military leadership but also as the medium of civilian communication in a widely decentralized economy. In keeping with its large volume, most of this Russian radio traffic was transmitted by automatic means, as explained in Appendix 7. The German Army intercepted this traffic with corresponding automatic equipment and evaluated it at the communication intelligence control center. Multiplex radioteletype links connected Moscow not only with the so-called fronts or army groups in the field, but also with the military district headquarters in Leningrad, Tiflis, Baku, Vladivostock, and in many other cities. In addition, the radio nets used for inland navigation provided an abundance of information. Although this mechanically transmitted traffic offered a higher degree of security against interception, the Russians used the same cryptosystems as in the field for sending important military messages over these circuits. The large volume of intercepted material offered better opportunities for German cryptanalysis. Strategic radio intelligence furnished information about the activation of new units in the zone of interior, industrial production reports, requests for materiel and replacements, complaints originating from and problems arising at the production centers and administrative agencies in control of the war economy. All this information

~~CONFIDENTIAL~~
~~Security Information~~

MS # P-038

-124-

was indexed at the communication intelligence control center where reports were drawn up at regular intervals on the following aspects of the Russian war production effort:

- Planning and construction of new factories;
- Relocation of armament plants;
- Coal and iron ore production figures;
- Raw material and fuel requirements for industrial plants;
- Tank and gun production figures;
- Transportation facilities and problems;
- Railway, inland shipping, and air communications;
- Agricultural production;
- Food distribution and rationing measures;
- Manpower, labor allocation, and other relevant matters.

Strategic radio intelligence thus made a slight dent in the Iron Curtain, which during the war was drawn even more tightly than at present, and offered some insight into the operation of the most distant Siberian production centers and the tremendous war potential of that seemingly endless expanse of land.

The last major achievement of German radio intelligence in Russia was the coverage of the gigantic preparations for the Baranov offensive during the first days of 1945. Even though the information submitted to higher headquarters did not lead to the logical tactical, strategic, and political decisions, communication intelligence cannot be blamed for the subsequent events. Once again the usual pattern of Russian radio communi-

MS # P-038

-125-

cation unveiled itself in front of the eyes of the German spectators who were condemned to impotence against the inexorable fate which was plunging them into the abyss. German communication intelligence, by then an instrument capable of distinguishing the finest nuance, perceived once more all the unmistakable signs of an impending offensive. First, the arrival of army engineers and the deployment of artillery, heavy mortar, and rocket launcher units which prematurely revealed the points of main effort of the inevitable concentrations of fire. Then the sparse higher-echelon traffic, which only traffic analysis and D/F plotting could evaluate and which indicated the transfer of division after division, corps after corps, and army after army, and revealed the structure of the "fronts." Finally, the gigantic proportions of the assembly forces poised for the attack were discernible from the abundance of tactical CW and voice messages, which could be easily broken, if not read simultaneous with interception. Once again the front-line divisions and tank units concealed their presence by imposing radio silence, which was not observed by the GHQ and NKVD units. Once more the combat reconnaissance teams, which at an early moment had been placed at forward points, disclosed the Russian long-range objectives in their radio traffic with the "front" headquarters. All these small pieces were put together to form a gigantic mosaic, which General Gehlen, the Chief of the Eastern Intelligence Branch, presented to Hitler and General Guderian, the Chief of the Army General Staff, during the first days of January 1945 with the assurance that, according to the observed transfers of command posts, the storm would break on 12 January.

Late in August 1944, after the collapse of Army Group Center, which

~~CONFIDENTIAL~~
~~Security Information~~

MS # P-038

-126-

had resulted from 150 Russian rifle and 45 tank divisions having opposed 42 German divisions at a ratio of strength of 4.5:1, the Russians controlled three large strategic bridgeheads west of the Vistula, at Baranov, Pulavy, and Magnussev. Early in September came a lull in the fighting, when the available Russian forces lacked sufficient strength to consolidate these three bridgeheads into one and to continue the offensive in the direction of the German border. At the beginning of October German communication intelligence had definite clues that the Russians were getting ready to resume the offensive from the three bridgeheads. During September the picture had been greatly obscured by the fact that they had switched to the defensive. During November the arrival of four new army groups, two opposite the East Prussian border and two between Modlin and Baranov, was observed. Points of main effort were being built up in the latter two areas from which thrusts in the direction of Baranov - Silesia - Saxony and Pulavy - Warthegau - Berlin were to be executed. By 9 January the disposition of strength between Russian and German forces had developed into a ratio of 11:1 for infantry, 7:1 for armor, and 20:1 for artillery. At the points of main effort the Russians had massed 400 guns per mile of frontage. In this area the Germans were still able to supplement the results of communication intelligence by air reconnaissance, which provided information on the arrival of motorized and tank units as well as data on the assembly of artillery forces which moved up during the hours of darkness.

When the storm finally broke on 12 January, the defense forces in the front lines, their superior headquarters, and the Chief of the Army

~~CONFIDENTIAL~~
~~Security Information~~

~~CONFIDENTIAL~~
~~Security Information~~

MS # P-038

-127-

General Staff were not surprised by the fury of the assault, the Russian points of main effort, or the directions of their attacks.

Prior to that, Hitler, who refused to admit the superiority of his hated enemy, Stalin, had told General Gehlen that his information reminded him of the ravings of a madman. Hitler was convinced that he was a genius who could ignore the timeless laws of warfare which permit a military leader to make major decisions solely on the basis of a clear and realistic estimate of the situation. Such an estimate must take into account all external factors and must stress realism and accuracy in the appraisal of one's own resources as well as those of the enemy. Hitler's disregard of the latter factor was perhaps due to the fact that his intuition had helped him to estimate accurately the real military potential and fighting ability of his initial enemies, the Czechs, Poles, and French, with greater accuracy than did many of his military advisers who had based their judgment on their World War I experience. To an intuitive estimate of the situation before the first shot was fired, the regular peacetime intelligence media, including communication intelligence, could make only modest contributions. Once the first overt act of war had been committed and a certain period of initial adjustment was over, German communication intelligence was able to furnish the military leadership with a wealth of reliable information which was appreciated by the General Staff and senior commanders in the field.

In the Russian theater the mass of minute details assembled by German communication intelligence over a period of years provided a clear,

~~CONFIDENTIAL~~
~~Security Information~~

~~CONFIDENTIAL~~
~~Security Information~~

MS # P-038

-128-

reliable, and almost complete picture of the military potential, the strategic objectives, and the tactical plans of the most powerful enemy which the German Army had ever encountered. The results were far superior to those obtained during World War I.

~~CONFIDENTIAL~~
~~Security Information~~

~~CONFIDENTIAL~~
~~Security Information~~

MS # P-038

-129-

Chapter Four
Appraisal of Radio Communication in Belligerent
Armies Committed in the European Theater

Although radio played only a minor part in the enemy's military operations, German communication intelligence was able to obtain much information which influenced the course of many an engagement. The author feels all the more qualified to express an opinion because he has more than thirty years of practical experience in radio communication and because his appraisal has been confirmed by other German experts in the field. In radio communication, as in other spheres of military endeavor, the old doctrine that effectiveness is more important than security retains its validity.

Any analysis of the radio communication of the three leading Allied powers during the recent war must answer the following three questions:

1. How sound were the initial Allied procedures in the fields of radio communication and cryptography from the point of view of security? What improvements did the top-level signal and intelligence officers introduce during the war, in order to comply with the intrinsically divergent objectives of effectiveness and security? What measures did they take to enforce operating procedures all the way down to the lowest-ranking radio operator whose transmissions were subject to interception by the enemy? What mistakes were made by these policy makers? -- These questions pertain to the methods adopted by Allied radio communication

~~CONFIDENTIAL~~
~~Security Information~~

MS # P-038

-130-

on the planning, executive, and supervisory levels.

2. What tactical use did the Allies make of radio communication? How effective was this medium and how safe was it, considering the fact that its security cannot but be limited? -- These questions pertain to radio operations in the field.

3. How effective and secure was radio communication of the individual arms of the Allied ground forces, of the other services which co-operated with the Army, of those organizations which were not under Army jurisdiction but were employed in the theater of operations, and finally of those Allied nations with whom the three Great Powers fought shoulder to shoulder? -- These questions are concerned with radio communication in a theater of operations and at the highest level of the military and political command.

I. The Russian Army

Russian radio communication in World War II had overcome the deficiencies with which it was afflicted during the First World War and the subsequent Revolutionary Wars up to 1920, namely the use of excessively primitive cryptosystems. During the occupation of eastern Poland in 1939 Russian radio operations were in the hands of prewar personnel who maintained a high standard. As early as the time of the Russo-Finnish winter war of movement, which required a great deal of flexibility from both signal officers and radio operators, a certain relaxation of radio discipline made itself felt, as a result of which security was jeopardized and the enemy was given access to secret information. This deterioration

~~CONFIDENTIAL~~
~~Security Information~~

MS # P-038

-131-

in security became more pronounced after the German invasion of Russia, when the fluctuating situation at the front made it impossible to exercise strict control over radio communication. These difficulties assumed even greater proportions when the Russians lost their best radio operators together with the flower of their peacetime Army. They were unable to train new personnel to the same degree of proficiency, especially after they suffered additional losses in 1942. The sudden abundance of radio sets which were delivered to them during the subsequent years induced the Russians to sacrifice quality for quantity. Up to the end of the war the Russians were incapable of remedying this dilutive process.

On the whole, Russian radio communication was well conceived and, though somewhat inflexible as judged by western European standards, properly adjusted to the level of intelligence of the average radio operator. The Germans soon discovered that their opponents used simple, conventional call signs which enabled them to identify quickly the stations of a given net. The Russians' use of authenticators also facilitated the work of German communication intelligence. As early as 1 April 1942 the Russians completely revised their radio procedures with the result that their security was tightened. German radio intelligence results thereupon decreased proportionately for a time. This improvement in Russian radio communication was offset by an intensification in the German intelligence activities which led to the observation of certain regularly-recurring, stereotopic subject matter, such as routine (form-type) reports and code names.

~~CONFIDENTIAL~~
~~Security Information~~

MS # P-038

-132-

At the same time the Russians continued to improve their cryptosystems, so that their high-echelon radio communications showed continuous progress with regard to security and could be solved only because the same systems were used along the entire front and the number of intercepted messages was therefore very large. In any event, it is only just to acknowledge that the responsible top-level Russian officials were successful in improving their radio communication throughout the duration of the war.

However, practical application in the field did not keep pace with the technological improvements. On the contrary, the inferior personnel made so many mistakes in operating the great variety of sets and other equipment that the security of Russian radio communication declined throughout the war. As in so many other fields, the principal causes for this decline were defective training, lack of discipline, and insufficient attention to minor details which, when added together, compromised the security of the entire Russian radio system. Moreover, there were certain other causes which contributed to this deterioration: slow transmitting speed, which enabled the speedier German intercept personnel to record and plot Russian signals, the previously-mentioned errors in keying, the failure to change code designations for frequently-recurring terms, localities, and data referring to time schedules and units, the use of the same cryptosystems over too extensive an area, and finally the transmission of messages in the clear without urgent necessity, especially in the form of voice conversations between tactical commanders. Obviously, in the heat of combat such mistakes are made by any belligerent, not just the Russians. In the case of the latter the Germans observed

~~CONFIDENTIAL~~~~Security Information~~

MS # P-038

-133-

that the Russian command repeatedly corrected the deficiencies by strict supervision and probably also by the threat of commensurate punishment. In addition to radio agents and numerous partisan radio stations, the very strictly supervised infantry and artillery units of the divisions in the line demonstrated excellent radio and cryptodiscipline. Among the tank forces adequate enforcement of radio discipline was frequently observed in the case of those few units whose commanders and signal officers pursued this objective with the necessary vigor. German communication intelligence was ineffective whenever Russian units followed ^{only} operating procedures to the letter by transmitting/absolutely essential messages, and whenever they changed their codes and ciphers frequently. However, it was much more frequently the case that Russian personnel violated the operating procedures, thereby providing German radio intelligence with numerous openings which helped in breaking their cryptosystems.

One of the chief factors which jeopardized the security of Russian radio communication was the almost unrestricted use of this medium by the various command echelons. Some of the reasons for this, such as the lack of wire communication and the great distances to be covered, have previously been discussed. These factors justify the Russian procedure in the light of the principle that effectiveness takes precedence over security.

The observance of radio silence as a security measure is in a category of its own. Realizing its effectiveness in achieving surprise, the Russians imposed radio silence each time they committed strategic reserves and tank units. After they had achieved absolute superiority over the

~~CONFIDENTIAL~~~~Security Information~~

~~CONFIDENTIAL~~~~Security Information~~

MS # P-038

-134-

Germans, the Russians no longer paid any attention to such minor details. In any event, by failing to observe radio silence, they lost the element of surprise and with it the necessary minimum of security. The Russians made little use of strategic radio deception. Great surprises, such as those achieved at Rostov, Moscow, and Stalingrad, were limited to instances in which German radio intelligence information was not believed by Hitler, who insisted that the Russians were using deception.

The third question to be answered in this analysis is by far the most significant one. Because of the fact that the entire well-conceived command structure and cryptosystems, as well as the efforts of disciplined radio operators, were undermined by an equal number of undisciplined radio operators, as was the case in the Soviet Army, the security of Russian radio communication was compromised. In spite of all the improvements in their radio communication and cryptosystems, the Russians actually left themselves as wide open to the enemy as in World War I, when every Russian offensive plan was revealed in advance.

It is almost beyond comprehension how the otherwise strict and ruthless Russian top-level command could leave such excessive latitude to individual units within the Army, with the result that GHQ artillery, rocket launcher, heavy mortar, engineer, and service formations compromised all the higher-echelon cryptosystems and tore the veil of security that had been created by the imposition of radio silence on all other units.

The same lack of discipline was observed in the radio operations of the NKVD units, which were certainly not under Army jurisdiction, since they were political organizations. In view of the highly-developed

~~CONFIDENTIAL~~~~Security Information~~

~~CONFIDENTIAL~~
~~Security Information~~

MS # P-038

-135-

security systems of the Russians, it seems remarkable that this condition was allowed to continue.

If the Russians attached any importance to the security of their radio communication and thereby to the secrecy of their plans — and in the light of a number of orders issued by Stalin this must certainly be assumed — they should have limited the number of radio stations to that for which fully-trained operators were available. With all the manpower that was at their disposal, they should have assigned a greater number of expert operators to supervisory positions and subjected radio communication of every unit in the Army to their control. Experienced intercept personnel should have been used for spot-check monitoring. Finally, the Russians should also have integrated NKVD radio communication into the Army system and standardized the operating procedures.

II. The British Army

British radio communication was the most effective and secure of all those with which German communication intelligence had to contend. Effectiveness was based on World War I experience in radio procedure and cryptology, in which the British Army learned many a lesson from the Navy. The higher-echelon cryptosystems of the British were never compromised in World War II. The radio operators were well trained and performed their work in an efficient and reliable manner. Nevertheless, there were also some defects. Feeling safe because of the security of their cryptosystems, the British neglected to take into account the openings which their radio communication left to German traffic analysis. Plain-text addresses and signatures contained in otherwise securely

~~CONFIDENTIAL~~
~~Security Information~~

~~CONFIDENTIAL~~
~~Security Information~~

MS # P-038

-136-

encrypted messages revealed the make-up of the British nets and thereby also the tactical interrelationship of units in which the Germans were interested. The stereotyped sequence in which stations reported into their nets indicated the structure of the chain of command, while British field ciphers were too simple and did not provide adequate security over extended periods of time. Either the British overestimated the security of their own systems, or underestimated the capability of German communication intelligence. The same was true of the radio traffic of British armored units, which used such simple codes and so much clear text that the Germans arrived at the conclusion that the British were unaware of their field radio communications' being observed.

In spite of impenetrable higher-echelon cryptosystems, excellent operating procedures, and efficient personnel, the security of the British radio communication in the United Kingdom during 1940-42 and especially in Africa in 1941-42, was so poor that, for instance, until the battle of El Alamein Field Marshal Rommel was always aware of British intentions. It was Rommel who repeatedly emphasized the predominant significance of radio intelligence reports in making an estimate of the enemy situation.

In this connection it may be pointed out that by no means all German field commanders recognized the utility of radio communication and intelligence. Many of them were quite prejudiced against these technological innovations. This may help to explain why the performance of some field commanders and their subordinate units so conspicuously surpassed or fell short of the general average. They were the ones who either deliberately or unconsciously simplified or complicated their mission

~~CONFIDENTIAL~~
~~Security Information~~

~~CONFIDENTIAL~~~~Security Information~~

MS # P-038

-137-

by making full use of or neglecting the facilities which were at their disposal.

What surprised the Germans was that the many tactical successes scored by Rommel as the result of his unusually profound knowledge of the enemy situation did not arouse the suspicion of the British and lead them to the realization that their own carelessness in radio communication was at fault.

According to British statements the most important booty captured during the break-through at El Alamein were the German intercept records. A quick analysis of this material opened their eyes and led them to introduce immediate reforms. The correction of the mistakes they had made over a period of several years and the thorough reorganization of their radio communication did much to improve their security.

As in the case of the other Allied armies, the Germans observed a general relaxation in British Army radio discipline, particularly in voice communication, during the course of large-scale fighting. As a result, the secrecy which had been maintained up to the beginning of an offensive was quickly lost. A few other deficiencies continued to be evident in British radio communication until the end of the war, such as for instance the inadequate encoding of place names in connection with grid co-ordinate designations.

The surprise achieved by the British during their landing operations was remarkable. It was accomplished simply by imposing radio silence. The British Army probably acquired this device from Navy.

~~CONFIDENTIAL~~~~Security Information~~

~~CONFIDENTIAL~~
~~Security Information~~

MS # P-038

-138-

Only in very rare instances did the British observe radio silence during ground operations. It seems incomprehensible why the British military leaders did not impose radio silence and use it in its more refined form, that of radio deception, more often. By achieving surprise, even during relatively minor engagements, they would have been able to reduce their losses.

In answer to the third question in this analysis it must be pointed out that even British radio communication was afflicted with a deficiency destined to compromise many of the Army procedures which had been so excellently devised and implemented. This deficiency was to be found in the radio communication of the Royal Air Force. The only possible explanation was interservice jealousy which led the RAF to overestimate the quality and security of its radio communication and to refuse to let it be subject to the supervision and control of the Army. At the same time Great Britain seems to have been without a unified armed forces command which would have restricted such separatist tendencies by exerting an authoritative, standardizing influence on the individual services. The RAF was certainly not aware, however, that it was responsible for revealing many carefully guarded plans of the Army and thus for many losses and casualties.

Whereas the RAF failed to adopt the superior radio operation procedures of the British Army and Navy, other Allies who subsequently entered the war, especially the United States, introduced the proved British methods, much to their advantage. Only France failed to do so, much to its disadvantage.

~~CONFIDENTIAL~~
~~Security Information~~

~~CONFIDENTIAL~~
~~Security Information~~

MS # P-038

-139-

During the last year of the Italian campaign the exemplary conduct of the British, with their wealth of experience, confronted German communication intelligence with a variety of problems. In this slower and more orthodox type of warfare strict control by the British achieved a high degree of radio discipline and was able to eliminate most of the national idiosyncrasies that characterized their radio communication. The standard of security in the Italian theater was extremely high.

III. The US Army

American radio communication developed very much along British lines. Up to 1942 domestic military traffic in the United States and that carried on by the first units to be transferred to the British Isles, revealed certain distinctive features, such as APO numbers, officer promotion lists, and unit designations and abbreviations which were at variance with their British equivalents. German communication intelligence had no difficulty in driving wedges at points where these features occurred and in compromising the security of American radio communication. The manner in which the US Army handled the traffic showed that its radio operators were fast and experienced. The comments made in the preceding section pertaining to the British cryptosystems are also valid for those of the Americans. The use of field cipher devices complicated German radio intelligence operations, even though their cryptosecurity was far from perfect.

The Americans deserve credit for the speed with which they adopted British operating procedures in 1942. They must have recognized the

~~CONFIDENTIAL~~
~~Security Information~~

~~CONFIDENTIAL~~~~Security Information~~

MS # P-038

-140-

progress made by their Allies, particularly after El Alamein. The Germans observed a continuous process of co-ordination aimed at eliminating the easily discernible differences between British and American procedures, except for linguistic differences which could not be erased. However, the radio discipline observed by British and American units alike while they were stationed in the United Kingdom deteriorated rapidly and reached the very limit of minimum security requirements as soon as US troops entered combat. The abundance of radio sets with which American units were equipped tempted the inexperienced US divisions to transmit far too many CW and voice messages in the clear. They thereby provided the German command with many clues regarding the tactical situation and US intentions and enabled German cryptanalysts to solve many an American cryptosystem. This criticism pertains particularly to the initial engagements in North Africa, and to the subsequent actions in Normandy and France, and to a lesser extent to those in Italy. In spite of the training during combined exercises in the British Isles, the security of American radio communication was extremely poor. During the later stages of the war the quality and security of radio communication was far from uniform in all the American armies. There were some armies whose radio traffic could hardly be observed, with the result that their intentions remained a secret. Other armies, either deliberately or unwittingly, denied themselves the benefits of radio security. Needless to say, in spite of their obvious superiority, this deficiency proved detrimental to them and resulted in needless losses.

~~CONFIDENTIAL~~~~Security Information~~

~~CONFIDENTIAL~~~~Security Information~~

MS # P-038

-141-

The comments made with regard to radio silence and deception in the section dealing with British radio communication apply equally to that of the Americans.

Apparently there existed no centralized US radio command agency responsible for raising the average performance to the quality and security standards set by the most disciplined units, or for keeping in check the arbitrary and unsatisfactory operating procedures of certain armies. Incidentally, the conclusions at which the Germans arrived on this subject were confirmed by MP radio operations during the Ardennes offensive. In this instance all established rules were violated and, given a somewhat less unfavorable distribution of forces, the final outcome might have been very different, since the German top-level command had complete information on US plans and operations. These happenings were in paradoxical contrast to the otherwise exemplary security measures taken by the Americans.

In conclusion, it may be said that the Americans' higher-echelon nets were just as secure as their British counterparts. Tactical net operation should indeed have measured up to the required security standards. Actually, however, over-all security was compromised by the many openings given to German communication intelligence by insufficiently disciplined lower-echelon units. That a maximum of security could have been achieved was demonstrated by the efficient radio operations of the US Seventh Army during the last year of the war, when the results obtained by German communication intelligence operations in the path of this army dropped to an extremely low level. Unified control and strict supervision

~~CONFIDENTIAL~~~~Security Information~~

~~CONFIDENTIAL~~
~~Security Information~~

MS # P-038

-142-

would surely have led to greater security among the US forces in general.

IV. The German Army

The German Army no doubt also made mistakes. In cases of extreme urgency German operating procedures permitted the sending of plain-text messages, after a written authorization from the tactical commander had been obtained. Inadequate training of replacements, especially field radio operators, led to the same mistakes and breaches of discipline as on the opposing side.

The great increase in the number and types of sets issued resulted in a deterioration of the effectiveness and security of German radio communication. Attempts were made to prevent serious blunders by monitoring the nets of divisions and higher units.

The second question raised in this analysis was given due attention by the Germans. The Chief of Army Signal Communication convinced the Army General Staff of the necessity of imposing radio silence in the assembly areas before the start of offensive operations. He also prohibited all practice traffic within newly-arrived units and relied on the peacetime training of the radio operators and the technical soundness of the cryptosystems. After surprise had been achieved at the beginning of an operation, radio traffic was immediately resumed with the usual efficiency. As soon as the telephone lines became available, either when the offensive ground operations came to a halt or when it became necessary to switch to the defensive, most of the German radio nets consistently closed down.

~~CONFIDENTIAL~~
~~Security Information~~

~~CONFIDENTIAL~~~~Security Information~~

MS # P-038

-143-

In World War I the German Ministry for Foreign Affairs refused to adopt the radio communication procedures of the Army despite the fact that the latter had far more experience in the matter. The authoritarian German government in the last war was equally unwilling to correct procedural deficiencies of nonmilitary agencies. In theory, the powers vested in the Chief of Armed Forces Signal Communication under the National Defense Act, enabled him to exercise strict, unified control over radio communication and cryptosecurity in time of war. However, he was unable to make any use of these powers, since in actual practice OKW could not prevail over the more powerful SS and National Socialist Party. The unilateral actions and blunders committed by the radio communication agencies of these organizations seriously compromised German security. Up to the end of the war the Germans were therefore unable to set up a unified control agency and to eliminate the most obvious deficiencies. At a very late date the cryptographic agencies -- and no others -- of the various services were unified under the sole authority of OKW, whose procedures were based on the longest experience and offered the highest degree of security.

V. Others

The over-all effectiveness of combined radio communication will always be determined by the weakest link in the chain, since it is this one which offers enemy observation its first opportunities to secure information. The first time this fact became apparent was during the

~~CONFIDENTIAL~~~~Security Information~~

~~CONFIDENTIAL~~~~Security Information~~

MS # P-038

-144-

Norwegian campaign. It was true in all instances where the French, who adhered to their own system, participated in combined operations, such as those in North Africa, Italy, and finally France proper. The transmission and cryptosecurity of French radio communication was below average before the war and in 1940. The complete revelation of the French troop dispositions in the Weygand Line as the result of unnecessary radio communication was a terrible blunder on the part of the top-level signal command and the French General Staff.

General Fellgiebel, the first Chief of German Army and Armed Forces Signal Communication, who was a radio and intercept expert, commented after the campaign in the West in 1940: "I had always hoped to see the day when tangible proof of the effectiveness of radio intelligence could be given by counting the number of enemy divisions right off a map. This has now actually happened. South of the Aisne and Somme thirty-six enemy divisions were reported by RI, and exactly thirty-six of them were actually found to be there, in the very areas where they had been plotted."

The fact that the French were still using their 1940 methods four or five years later and that they did not adopt the superior British ones as did all the other Allies, indicated a lack of progressive thinking and faulty individualism which compromised the security of the French military command, not to mention that of their Allies.

~~CONFIDENTIAL~~~~Security Information~~

~~CONFIDENTIAL~~~~Security Information~~

MS # P-038

-145-

It was probably because of former close ties with the French, that the performance of Czech radio communication was below average.

In keeping with the general characteristics of the Poles, the radio communication of the Polish Army was over-organized. By overemphasizing security to the detriment of effectiveness, the Poles dug their own grave. By the same token, during the later stages of the war radio operations of Polish partisans and resistance groups attained a high level of transmission and cryptosecurity.

VI. Summary and Conclusions

German communication intelligence scored its greatest and most striking successes not by laborious and systematic traffic or cryptanalysis, but rather by taking advantage of enemy blunders which violated the written and unwritten rules governing radio operations. Neither the Americans nor the Russians maintained perfect security. During the last year of the war only the British came close to achieving a fairly satisfactory degree of security. That adequate security could have been maintained was demonstrated by several disciplined American and Soviet units.

The security of radio communication, which is absolutely essential in the exercise of command over the armed forces of a nation can be obtained only by setting up a unified control agency. Its functions must include the surveillance of all military and nonmilitary agencies which are permitted to use radio communication in wartime. Moreover, this

~~CONFIDENTIAL~~~~Security Information~~

~~CONFIDENTIAL~~
~~Security Information~~

MS # P-038

-146-

central control agency must monitor radio traffic, introduce and supervise uniform training programs, set the highest standards in traffic-handling technique and of cryptosecurity, and exhaust every possibility for improving operating procedures on the basis of the experience in the field of communication intelligence.

These measures should be introduced in peacetime or at least be ready for implementation at the outbreak of war. Very far-reaching powers must be granted to the men in charge of this radio control agency.

~~CONFIDENTIAL~~
~~Security Information~~

~~CONFIDENTIAL~~~~Security Information~~

MS # P-038

-147-

Chapter Five

Radio Intelligence Activity of the German Armed Forces

High Command — Conclusions

The communication intelligence units of the three services co-operated closely during joint operations, such as the German campaigns in Norway, Africa, Italy and other theaters. The Navy had special RI units which observed foreign naval movements and maritime traffic in general. Similarly, the Luftwaffe organized a radio intercept service to observe enemy air traffic. Both the Navy and Luftwaffe RI agencies co-operated closely with the respective radar systems for the purpose of directing German submarine and air attacks and of intercepting the corresponding enemy countermeasures.

It is no secret that the British soon made up for the initial advantage held by the Germans in the field of radar and then retained undisputed leadership. Many will remember Sir Stafford Cripps' statement that the British radar system was more decisive for the outcome of the war than the atom bomb.

The new German schnorkel submarines which were "D/F proof" came out too late. The intercept service of the Luftwaffe provided information for the air-raid warning system in Germany. In most cases Luftwaffe intercept units were able to follow enemy squadrons during their entire flight, from take-off to landing, largely on the basis of interplane

~~CONFIDENTIAL~~~~Security Information~~

MS # P-038

-148-

conversations. These transmissions were heard on the ultrashort wavelengths.

During World War II other German agencies carried on communication intelligence, but their achievements cannot be compared with those of the Armed Forces. The Cryptographic Branch of the Armed Forces Signal Communication Group which was staffed mainly with Army personnel, was responsible for developing and testing cryptosystems and for observing diplomatic and other international radio traffic. There were two reasons why this mission, which exceeded the scope of the Army and Armed Forces assignments, was turned over to a military agency.

First of all, the Ministry for Foreign Affairs did not have any corresponding service, and so the more experienced military took over the observation of diplomatic communication channels. Following the misfortunes experienced by German diplomacy in the field of cryptography during World War I, the military and diplomatic services co-operated closely. This co-operation continued until the end of the war. The wealth of material produced by the observation of this high-level radio traffic provided military personnel with ample opportunities for practice in cryptanalysis. This was the only worthwhile material which provided a suitable basis for analyzing extremely difficult cryptosystems and which could aid in the development of new cryptanalytic methods. The personnel engaged in interpretation also scored notable successes.

~~CONFIDENTIAL~~
~~Security Information~~

MS # P-038

-149-

In the Cryptographic Branch, there were thirty-seven "desks" for an equal number of countries; they were responsible for intercepting and solving messages to and from virtually every country in the world. The Russian diplomatic codes were the most impregnable, and the Russian desk was therefore the most unproductive. Nothing could be learned from Moscow except by intercepting radio dispatches from diplomats accredited to the Russian government. Especially careless were the Turks, whose messages were regularly decoded without effort, even after they had been warned by the Germans. This was an ideal way of keeping a check on Japan. Hitler ordered that no request/^{be}made of the Japanese to improve their cryptosystems. As it turned out, this decision was probably of the greatest advantage to the United States, which was able to break the insecure Japanese cryptosystems throughout the war. Chinese messages were not resistant to analysis either. The more advanced a nation, the more difficulties confronted the German cryptanalysts in their efforts to break its codes. However, there was no unified control over US cryptosecurity, so that the Germans were able to accomplish routine solution of messages to and from one official American agency in Switzerland.

Cryptanalyzed intercepts whose contents were important were disseminated to a small number of top-level officials as "reliable information." Those destined for Hitler were transmitted by teletype cryptogram and submitted to him without delay.

~~CONFIDENTIAL~~
~~Security Information~~

~~CONFIDENTIAL~~
~~Security Information~~

MS # P-038

-150-

In contrast to other countries, German communication intelligence was not subordinate to the counterintelligence secret service, but remained a part of the signal communication organization except for a brief period from approximately 1928-35, when the cryptographic functions were assigned to counterintelligence. Communication intelligence had its origin in and was developed by the signal communication organization. Under Signal auspices it was in an optimum position to improve its cryptosystems and to benefit from the latest advances in radio technology. Old as it may be, this fundamental question of command channels is still the subject of dispute. The achievements of German communication intelligence in World War II may speak in favor of the German type of intelligence organization, which relieved the Army General Staff of direct command responsibilities and technological problems. Co-operation between these two agencies was close and the Staff was provided with the desired information in finished form.

However that may be, modern statesmen and military leaders will make ample use of communication intelligence to obtain information. On the other hand, they will strive to protect their own country's radio communication from mistakes and failures by imposing strict control and surveillance and by drawing up well-considered agreements with allied nations in order to provide a maximum degree of security. In all countries there is a need for maintaining the security of certain military and foreign policy decisions, lest their effect be compromised from the outset.

/s/ Albert Praun

~~CONFIDENTIAL~~
~~Security Information~~

~~CONFIDENTIAL~~~~Security Information~~

MS # P-038

-151-

APPENDIX I

Historical Survey of German Radio Intelligence

(1918 - 45)

I. 1914 - 18

In 1914 the German Army had no units for the observation of enemy radio traffic and its radio equipment was inferior to that of the far more advanced Russians. During the Battle of Tannenberg, a chance occurrence led to the interception of plain-text messages sent by the Russian Second Army, in which the commanding general, Samssonov, revealed his intentions by having orders to subordinate corps transmitted in clear text in order to avoid any delay and errors inherent in encryption and decryption. The revelation of these enemy orders proved to be an unexpected boon to the German command. However, because of an indiscretion on the part of the German newspapers, the Russians soon realized what had happened. The rigid enforcement of secrecy and strict use of cryptographic systems in the ensuing operations soon dried up this prospective source of intelligence, but the steadily improving intercept organizations which employed mathematicians as cryptanalysts, first in the Austro-Hungarian and later also in the German Army, eventually broke all the Russian ciphers. Subsequently, German cryptanalysts often solved messages before their proper addressees could receive and decrypt them. Poorly trained Russian operators frequently requested the transmitting

~~CONFIDENTIAL~~~~Security Information~~

~~CONFIDENTIAL~~
~~Security Information~~

MS # P-038
App. I

-152-

station to repeat its messages, which had already been received by superior German operators, solved by experienced cryptanalysts, and submitted to the German tactical commanders for use in planning their countermeasures.

The Russian cryptosystems continued to be compromised throughout World War I, so that the Chief of Staff of the Commander in Chief in the East, General Hoffmann, was later able to write in his book The War of Lost Opportunities (Der Krieg der versaeumten Gelegenheiten) that "thanks to this intelligence medium every Russian offensive was revealed beforehand to the German command during the entire course of the war."

Corresponding blunders were committed in the West by German cavalry units transmitting plain-text radio messages which the French called "Marwitz telegrams" (Marwitztelegramme). In this instance the reason for transmitting in the clear was that, because of the precipitate mobilization of these cavalry units, the cryptographic material which the General Staff had prepared for distribution did not arrive in time, and thus the radio stations had to move into the field without it.

Another serious blunder of German radio communication aroused world opinion during the same war. This was the so-called "Zimmermann note," which the German Ministry for Foreign Affairs sent to Mexico, urging that country to take hostile measures against the United States. This slip was decisive in turning the US against Germany. Up to the end of

CONFIDENTIAL
Security Information

~~CONFIDENTIAL~~
~~Security Information~~

MS # P-038
App. I

-153-

the war, in spite of repeated warnings from the military, the German diplomatic agencies inexcusably overestimated the security of their primitive cryptosystems. The highly efficient British intercept service was able to break the messages sent by the big station in Nauen to the detriment of the effectiveness of German diplomatic and military policies.

During World War I the observation of British ship movements by German Army and Navy intercept units provided essential information for submarine warfare. Because of the high quality of the British Army's cryptographic systems, its radio messages were often not solved until it was too late. In some instances the solution of other enemy systems also required several weeks or even months. Nevertheless, the Germans derived certain tactical advantages, even from the belated solution of intercepted messages, not to mention the progress made in the art of cryptanalysis.

As early as 1915 special German radio stations attempted to jam transmissions from the crude, damped-wave apparatus carried by British air observers, who used the Morse code. These attempts were unsuccessful, because the signals transmitted by the airplane were always stronger at the observation battery's receiver than were those sent out by the jamming stations. Consequently, the jamming stations soon switched over to the intercepting of enemy requests for fire against German batteries, whereupon they warned the latter before they came under attack. Opposite the French sectors of the front the same system was later used

~~CONFIDENTIAL~~
~~Security Information~~

~~CONFIDENTIAL~~~~Security Information~~MS # P-038
App. I

-154-

by small intercept units attached to various German corps. Here, too, the enemy was unable to maintain secrecy, because the devices used for concealing designated targets were too simple.

In World War II the life of many a German artilleryman was saved by the same type of warning service, which by then was used on a large scale both in Italy and France.

When the American Expeditionary Force arrived in France in 1917, it displayed utter carelessness with regard to signal discipline. Its telephone security in the trenches was so poor that German wire intercept efforts proved highly effective in contrast to the lack of results obtained along the British and French sectors. Since telephone communication was readily available, radio traffic was at first of only secondary importance. Warned by their more experienced Allies, the Americans gradually raised their own security standards to the same level which the Germans, French, and British had achieved as the result of dire experience.

In 1928-29 Soviet military authors raised the question whether inadequate radio security had been one of the reasons for Russia's defeat in World War I. Some fanatics even maintained that this deficiency was solely responsible. The discussion of this subject ceased in 1930, apparently upon a hint from above. However, the Russians had every reason to weigh this problem. Even in 1920 the radio and cryptographic discipline of the Red Revolutionary Army in the war against Poland was so inadequate that the Polish intercept organization under the direction of French instructors had no difficulty in observing all Russian movements, especially those of

~~CONFIDENTIAL~~~~Security Information~~

~~CONFIDENTIAL~~
~~Security Information~~MS # P-038
App. I

-155-

Budenny's Cavalry Army, which was advancing from the south. This enabled General Weygand to obtain valuable information for his decisive counter-attack.

The World War I achievements of German radio intelligence which initially was improvised and later systematically developed, made it appear necessary for the Reichswehr to utilize this experience and, in spite of

*
Tr: The German National Defense Establishment (an army of 100,000) provided for by the Versailles Treaty.

all restrictions, to provide such facilities as would encourage and promote this activity.

2. 1918 - 36

The military clauses of the Versailles Treaty provided that the seven infantry and three cavalry divisions of the Reichswehr, whose strength was limited to 100,000 men, would be allowed seven division signal battalions, each comprising two companies, one of which was to include an intercept platoon. In addition, the Germans were permitted to assign signal personnel to schools, garrisons, and headquarters and to maintain twelve major military radio stations at Koenigsberg (I), Stettin (II), Spandau (III), Dresden (IV), Stuttgart (V), Muenster (VI), Munich (VII), Frankfurt an der Oder (1), Breslau (2), Kassel (3), as well as at Nuernberg and Hanover. The Roman numerals in parenthesis designate military district headquarters; the Arabic numbers, cavalry division headquarters. The Treaty did not,

~~CONFIDENTIAL~~
~~Security Information~~

~~CONFIDENTIAL~~
~~Security Information~~

MS # P-038
App. I

-156-

however, provide for any communication intelligence units.

Realizing that intelligence was of particular importance to an army restricted with respect to strength and equipment, the German military leaders decided at an early date that the radio intelligence operations initiated during World War I should be continued and further developed within the framework of available means. These activities were given the official designation Intercept Service.

The above-mentioned stations employed highly qualified operators, whose time was completely taken up with their routine duties. These stations were therefore selected for radio intelligence operations. During the second half of 1921 the officers in charge of the stations were issued specific orders to guard certain foreign radio channels. The stations in Muenster, Hanover, Kassel, Stuttgart, Nuernberg, and Munich intercepted chiefly British and French traffic, while those in Stettin, Spandau, Breslau, Dresden, Frankfurt an der Oder, and Koenigsberg observed primarily Polish, Russian, and Czechoslovak traffic. The advisor to the senior signal officer on the staff of each of the two corps headquarters at Berlin and Kassel was in control of communication intelligence operations. These two officers reported directly to the Signal Inspectorate of the Reichswehr Ministry whenever they had obtained information of special interest.

At first the Germans merely intended to gather information about foreign military procedures as a basis for traffic analysis, including such elements as frequencies, signs, prosigns, operating signals, hours

~~CONFIDENTIAL~~
~~Security Information~~

DEVELOPMENT OF
THE RADIO INTERCEPT SERVICE
1921-1939

MS No. P-038 Chart I App. I

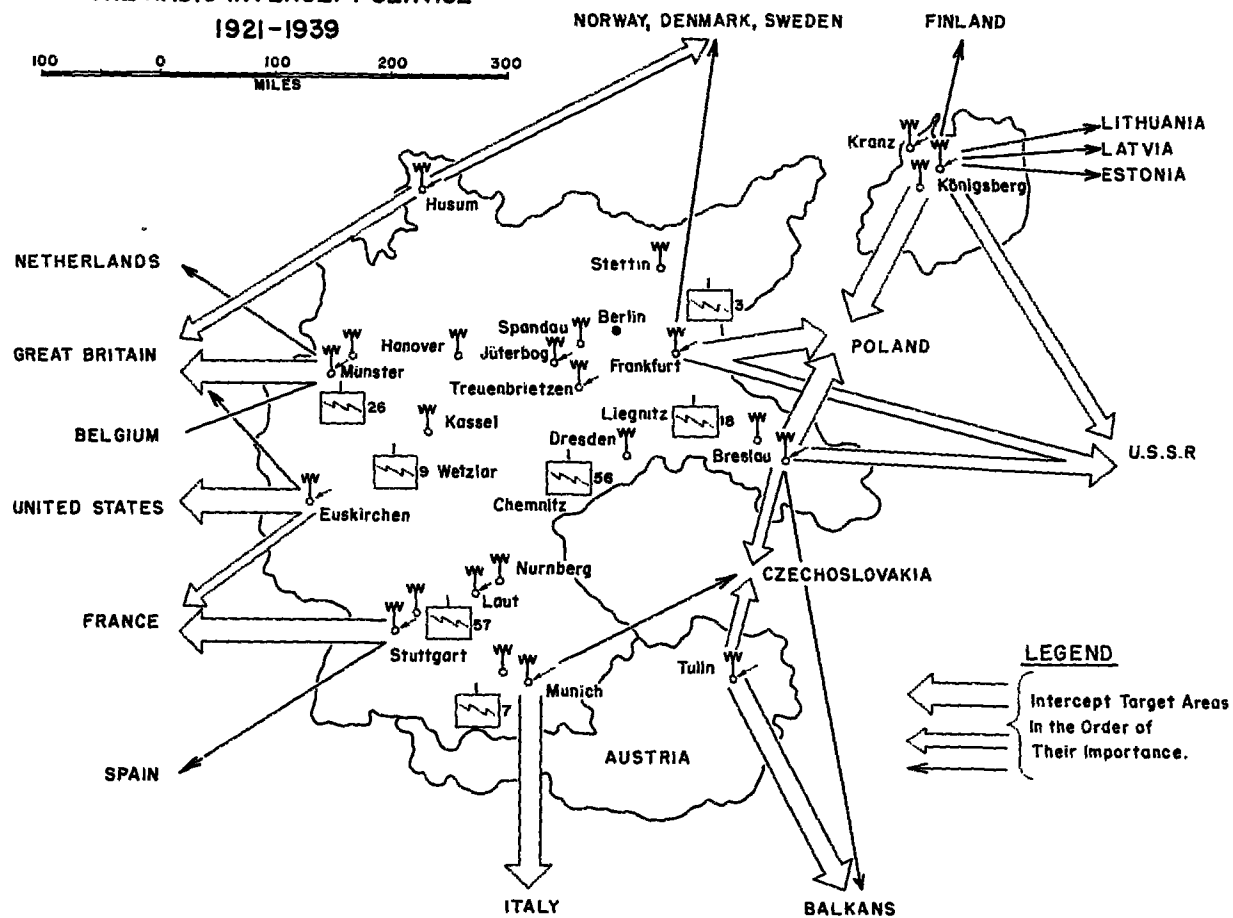

~~CONFIDENTIAL~~
~~Security Information~~

MS # P-038
App. I

-157-

of operation, traffic handling procedures, and apparatus in use. Only gradually did their analysis embrace an evaluation of internet relationships. No provision had yet been made for text analysis, i.e., the translation of foreign language messages in plain text and the solution of encrypted ones.

After a short while the number of intercepts grew so large that they could not all be processed. The two principal disadvantages of the then current procedure were the lack of a unit to perform preliminary screening at the receiving station and the employment of personnel for both radio and intercept duties. In 1924 it was therefore planned to establish special intercept stations, whose personnel were to specialize in the interception and evaluation of foreign radio communication.

In 1925 intercept stations were established at Koenigsberg (I), Frankfurt an der Oder (III), Breslau (IV), Stuttgart (V), Muenster (VI), and Munich (VII). The personnel strength of each station was one officer, three noncommissioned officers, fifteen male and five female radio operators, and three translators. The stations were gradually equipped with sensitive receivers covering a frequency range of from 100 to 3,000 kc. Their operations were to be kept completely separate from those of the radio stations, and they were located in different buildings. (See Chart 1)

Because of the low personnel strength, uninterrupted around-the-clock listening schedules could be maintained on only three or four of the receivers. The training schedule called for the best intercept operators to be

~~CONFIDENTIAL~~
~~Security Information~~

MS # P-038
App. I

-158-

trained as analysts, while the translators were first to be used on plain-text messages and were then gradually to be trained in solving simple ciphers. The commanders of the intercept stations were to maintain contact with the counterintelligence agencies at military district headquarters.

Each intercept station was to cover certain countries according to established priority ratings. An area which was given top priority, was covered by at least two stations, which exchanged their results. Interception was no longer confined to military traffic but was extended to all radio communication, except naval, for which the German Navy had established its own communication intelligence agency. The Army became more and more interested in diplomatic radio traffic, since it provided the only material for the analysis of difficult cryptosystems.

The Germans continued to place emphasis on the observation of the radio traffic of foreign armies for the purpose of ascertaining their organization, strength, and distribution of forces. In this connection the observation of foreign maneuvers assumed great significance, and D/F training was accentuated in order that a detailed picture of these maneuvers might be pieced together.

All permanent intercept stations had originally been issued a recent model of the Navy-type direction finder. In 1928 they were equipped with loop-antenna sets which could be used in the field. They surveyed for D/F station sites near the borders and made radio compass calibrations at regular intervals with the aid of mobile target transmitters. Foreign maneu-

~~CONFIDENTIAL~~~~Security Information~~

MS # P-038
App. I

-159-

vers were observed by stations along the base lines thus established. This procedure was fully effective in intercepting higher-echelon messages -- in general down to and including division level -- whereas the tactical information obtained from lower-echelon units was at first inconclusive.

After 1928 the attention of German signal experts was focused on the observation of short-wave traffic, and a study of the effectiveness of short waves at all hours of the day and night, as well as under different weather conditions was initiated.

From 1930 on efforts were made to plot medium-wave transmitting stations operating between 1,000 and 3,000 kcs. In 1931 automatic high-speed reception was introduced employing wax disk, tape, and other sound recorders.

The Signal Inspectorate established a cryptographic section which was incorporated into the Counterintelligence Branch of the Reichswehr Ministry. A central intercept station was attached to the Cryptographic Branch. The position of evaluation officer at corps headquarters was abolished. The Cryptographic Section took charge of the intercept stations, assigned missions, acted as central evaluation agency, and was responsible for the solution of the complicated cryptosystems that could not be solved at intercept station level.

The observation of maneuvers from fixed base lines led to the idea of using mobile equipment for intercept operations. In 1930 the Cryptographic Section requested the Army Ordnance Office to develop special trucks for radio receiving, D/F, and evaluation units. This equipment was delivered

~~CONFIDENTIAL~~~~Security Information~~

MS # P-038
App. I

-160-

to the signal unit of the Artillery School. The first tests conducted by the new units, which formed one intercept platoon, took place at the same time that experiments were being conducted with medium-wave sets having a 5-watt output and a frequency range of 950 to 3,150 kc. The tests proved that intercept units were able to keep up with the fast-moving action of a meeting engagement, provided the necessary communication net for relaying the results could be established.

The intercept platoon was issued additional equipment and its strength was increased to form a company, whose table of organization was as follows: two medium-wave intercept platoons, one long-wave intercept platoon, a messenger section, a communication team, and an evaluation team. The medium-wave platoon each had one intercept team, one target transmitter, and three D/F teams. The long-wave platoon had three intercept teams, one target transmitter, and three D/F teams. The long-wave intercept platoon was to observe higher-echelon traffic. For this purpose the three intercept teams had to be in close proximity, while the long-wave D/F teams were distributed over a 100-125 mile base line, in order to obtain azimuths which would approximate right angles as nearly as possible. The medium-wave intercept platoons were to be distributed along shorter base lines, with their intercept teams at the same location as the D/F teams. All teams were to be echeloned forward so that they could intercept tactical radio traffic. In addition to their function in radio compass correction, the radio sets issued to each platoon were used to dispatch orders and to report urgent information to higher

~~CONFIDENTIAL~~~~Security Information~~MS # P-038
App. I

-161-

headquarters. The T/O strength of the company was 10 officers (including civilian evaluation personnel with assimilated rank) and 250 enlisted men.

the
When/experimental intercept company was first tested, it was attached to a corps headquarters with the mission of observing units which were operating under simulated combat conditions. Without solving any messages, the company was able to plot the entire higher-echelon and the essential elements of the lower-echelon command structure solely by observing the traffic between the various stations.

3. 1936 - 39

When Germany decided to rearm in 1936, twelve corps and thirty-six divisions with a proportionate number of GHQ units were organized. The intercept units were at first among the latter. Top-level planning was concerned with increasing the number of fixed intercept stations, forming additional mobile intercept companies, and clearly defining the mission of both the fixed and the mobile intercept units.

Since each military district headquarters had its own intelligence agency, it seemed desirable to add an intercept unit, especially since their activities complemented one another. The logical solution would have been to set up one fixed intercept station at each new military district headquarters. Moreover, the unification of the services under an armed forces high command was in the planning stage, and such a command agency could not function properly without an intercept organization. The implementation of this plan would necessitate the establishment of fixed Armed Forces intercept stations, whose primary function would be to observe diplomatic radio traffic

~~CONFIDENTIAL~~~~Security Information~~

~~CONFIDENTIAL~~
~~Security Information~~

MS # P-038
App. I

-162-

and thereby relieve the existing stations.

Mobile intercept companies were to be integrated into the strategic and tactical ground and air reconnaissance units (the army and division signal battalions of the Army and the long-range and close-range reconnaissance squadrons of the Luftwaffe). The intercept companies were to receive their peacetime training by covering foreign maneuvers and similar activities. To accomplish their mission they needed the data compiled by the fixed intercept stations, particularly that derived from traffic analysis. The question of whether fixed intercept stations should be converted into mobile companies in the event of mobilization was answered in the negative, although it was to be expected that the workload of the fixed stations observing a potential enemy country would gradually diminish after the outbreak of hostilities. However, it was precisely during the periods of tension, such as prevailed during the assembly and concentration of forces, that the information furnished by the fixed intercept stations would be indispensable, since the personnel of the intercept companies had not completed their training and were not ready for full-scale operations.

Since the mobile intercept teams forming part of the experimental intercept company had achieved their best results in dealing with higher-echelon traffic, the initial plans called for the formation of intercept companies for long-range radio intelligence. At least one intercept company was to be included in the T/O of each army headquarters. The solution of the problem of tactical or short-range radio intelligence was postponed for the time being.

~~CONFIDENTIAL~~
~~Security Information~~

~~CONFIDENTIAL~~
~~Security Information~~

MS # P-038
App. I

-163-

The immediate full-scale implementation of these plans was delayed primarily by the shortage of personnel. The 100,000-man Reichswehr had only a restricted number of radio intercept operators. They were, however, highly qualified as a result of the then-current twelve-year enlistment period. It was doubtful whether personnel with only two years of service could master the duties of intercept operator. During only the first year of service it was altogether impossible to transform recruits into reliable operators. Since the Army, unlike the Luftwaffe, was not authorized to extend involuntary periods of service, the solution was adopted whereby an unusually high percentage of permanent civil service workers and non-commissioned officers with long terms of enlistment was employed.

In order to train the personnel needed for the newly-activated units, an intercept training company was temporarily established within the framework of the training and experimental center of the Army Signal School. This company and the fixed intercept stations provided the personnel needed for activating the first two intercept companies, which were trained for operations covering western and eastern Europe respectively. In 1939 the intercept training company was transformed into a training platoon, whose principal assignment was to test new intercept apparatus. By the outbreak of the war seven companies had been activated, three of which (the 9th, 26th, and 57th Intercept Companies) were trained for observing the traffic of western Europe, and four (the 3d, 7th, 18th, and 56th Intercept Companies) for east and southeast European coverage.

During the activation of these mobile units, a new fixed OKW station

~~CONFIDENTIAL~~
~~Security Information~~

~~CONFIDENTIAL~~~~Security Information~~MS # P-038
App. I

-164-

was established at Treuenbrietzen, and the fixed Army station at Frankfurt an der Oder was moved to Jueterbog. Another OKW station was opened at Lauf, and three OKH stations at Lusum, Euskirchen, and -- after the annexation of Austria -- at Tulln. Preparations for transferring the fixed Army station at Koenigsberg to Kranz were underway. All fixed stations were greatly expanded with respect to both personnel and equipment. Their new T/O strength was twenty-five officers and civilians, fifty noncommissioned officers, and seventy-five male and female operators. The D/F sites near the border, which hitherto had merely been surveyed, ^{were} occupied by teams and put into service as advance intercept and D/F stations under the cover designation of "radio security posts." The fixed stations together with these radio security posts, now operated an average of twenty intercept installations, each of which operated at least two D/F stations.

After 1936 individual intercept companies had been attached to corps and army headquarters during German maneuvers. The judgment, previously arrived at, that the gathering of tactical intelligence was beyond the capacity of intercept companies was confirmed, and it was found that they were fully occupied with long-range intelligence operations. In order to observe the radio traffic within opposing division areas, a platoon for medium and short-wave interception and for medium-wave D/F was attached to each radio company which was part of a corps signal battalion. These platoons, however, obtained poor results. Their failure was due to the

~~CONFIDENTIAL~~~~Security Information~~

~~CONFIDENTIAL~~
~~Security Information~~

MS # P-038
App. I

-165-

difficulty in giving the personnel proper training, in providing them with essential evaluation data, and in keeping them in practice. Moreover, there was still no method for expediting the transmission of information to division headquarters, so that it would arrive in time.

Division commanders had to be provided with tactical radio intelligence which would complement their combat reconnaissance. To this end each division signal battalion was assigned one communication intelligence to platoon which was form part of the radio company. These platoons were equipped with receivers designed primarily to intercept enemy voice traffic, and with equipment for intercepting telephone conversations. The impossibility of testing them under wartime conditions made it impossible to go beyond the stage of initial organization. Employment against German signal communication provided no criterion for estimating the difficulties which would be encountered in intercepting foreign-language messages. The efficiency of that operation depended entirely on the availability of linguists, who had to be given extremely careful training in military terminology. Deficiencies which had already become apparent in the corps intercept platoons were equally difficult to eliminate. Real improvements in the performance of short-range communication intelligence could be introduced only under the pressure of direct enemy action.

From the former Cryptographic Section^{of} the Reichswehr Ministry emerged two new agencies: the Cryptographic Branch of OKW, which included specialists from the Navy and Luftwaffe, and the Evaluation Control Center of

~~CONFIDENTIAL~~
~~Security Information~~

LIS # P-038
App. I

-166-

OKR, which was formed as an independent unit within the Signal Inspectorate in the General Army Office. The Cryptographic Branch of OKW was responsible for co-ordinating the radio intelligence activities of all three services and maintaining contact with the Counterintelligence Branch, which had become part of OKW. The Evaluation Control Center was in charge of all Army intercept activities and made its service available to the Army General Staff.

During the construction of the West Wall in 1938, an intercept battalion was formed on an experimental basis. It consisted of three mobile companies, one fixed station, and an evaluation center which was directly subordinate to the battalion staff. The mission of the battalion was to observe the large-scale maneuvers, which the French Army was executing in the Chalons-sur-Marne area, in order to ascertain whether French forces were being moved up from there to Germany's western frontiers and to obtain complete coverage of the French border areas behind the Maginot Line. To cope with this assignment each mobile intercept company was subsequently organized to consist of one evaluation, one intercept, one D/F, and one communication platoon.

The evaluation platoon continued to be responsible for traffic and cryptanalysis, the results of which were improved by the introduction of new techniques derived from recent experience.

The intercept platoon, comprising thirty receivers for the long, medium, short, and ultrashort wavelengths, established a main intercept

~~CONFIDENTIAL~~~~Security Information~~

MS # P-038
 App. I

-167-

station and set up advance posts in accordance with the requirements of the situation.

The D/F platoon was issued eight long-medium wave loop antenna sets. (The highly-sensitive goniometer was gradually replacing the old loop-type sets.) The platoon then established four stations with two D/F sets per station, thus permitting each one to keep up with enemy movements by leap-frog commitment of its teams. A D/F control system had been introduced, enabling all the direction finders along the base line to be brought to bear simultaneously against any enemy transmitter plotted by the main intercept station. The station at company headquarters was responsible for maintaining contact with the individual teams. Each D/F station was issued a transmitter, so that it could report its findings to the evaluation platoon. This same set was used as a target transmitter for providing radio compass data for the other teams.

The communication platoon was a service unit comprising a motorized messenger section and a wire team. The latter layed lines connecting the teams with the D/F NCS at company headquarters, installed a remote control circuit for that NCS, put in lines connecting outlying D/F posts with the higher-echelon command net and the Reichspost, and provided telephone and

* Tr: The German government postal, telephone, and telegraph agency

teletype connections between the intercept company and superior headquarters. Attempts to establish intra-company microwave links had not been very successful.

~~CONFIDENTIAL~~~~Security Information~~

~~CONFIDENTIAL~~
~~Security Information~~

MMS # P-038
App. I

-168-

Intercept operations against the French met with unexpected difficulties. They apparently made full use of their wire lines and exercised extreme caution in radio communication. The personnel engaged in evaluation and interpretation were faced with the ever-present problem of determining whether radio silence indicated the absence of enemy forces in the target area or a carefully disguised assembly of forces. It required the utmost alertness on the part of the D/F teams to distinguish the traffic within the target area from that which originated outside it. This was all the more essential because the cryptosystems which were encountered at first could not be solved, and thus there were no clues for determining the location of units. If the difficult cryptosystems were to be solved, a sufficient volume of messages had to be intercepted. This was achieved by employing more than one intercept company with a correspondingly larger number of receivers, which covered a very wide frequency range. Unavoidable errors made by individual operators could be corrected through deliberate double coverage of the same channels by different units and through a comparison of the results.

German communication intelligence finally succeeded in establishing beyond doubt that no large-scale maneuvers were taking place in the area under observation. This information could be obtained because the French failed to change ciphers often enough.

During these intercept operations an attempt was made to use the RI platoons of the German divisions then deployed along the West Wall for tactical short-range intelligence, particularly in intercepting the (ground wave) signals emanating from French fortress units near the border. The

~~CONFIDENTIAL~~
~~Security Information~~

~~CONFIDENTIAL~~
~~Security Information~~

MS # P-038
App. I

-169-

attempt was successful in two instances when skilled linguists acted as intercept operators.

A condensation of the results obtained by all the intercept units was submitted by the evaluation center to the Army General Staff, to Army Group Headquarters 2 at Frankfurt am Main, and to Frontier Fortification Headquarters at Kaiserslautern. The results were subsequently confirmed by other sources of information.

These experimental operations along the French border formed the basis for subsequent procedures used in wartime. In drawing conclusions the German planners did not overlook the fact that these operations were carried out by fixed stations, which experienced little difficulty in controlling the intercept units, and in reporting their results. Obviously, mobile operations during an advance or attack would present far greater problems. This point in particular led to the decision to issue more trucks to the intercept companies, so that their operations would not be interrupted for a single moment during a change of position. Moreover, although intercept operations along the West Wall favored a lateral disposition, the possible advantages of echeloning intercept units in depth had to be studied in the light of a war of movement. In the field of higher-echelon radio intelligence it was decided to establish an evaluation center at each army group headquarters. Each center was to analyze the results obtained by the intercept units operating within that army group area. The problem of forwarding the information in time was not underestimated, but was considered possible of solution.

~~CONFIDENTIAL~~
~~Security Information~~

~~CONFIDENTIAL~~~~Security Information~~MS # P-038
App. I

-170-

In order to make tactical radio intelligence more effective, plans were considered for detaching the RI platoons from their respective divisions, organizing them into companies, and placing them under the command of the intercept battalion. When attempts were made to introduce this measure, its advocates could not override the objections to the delay in the transmission of information held to be indispensable by the division commanders. Consequently, although the formation of equally efficient long-range and short-range RI units appeared logical and desirable even at that time, it was not accomplished.

4. 1939 - 45

At the outbreak of war the intercept organization of OKH consisted of the following agencies:

- a. The Evaluation Control Center at OKH with its subordinate fixed Army intercept stations;
- b. The evaluation centers attached to each of the three army group headquarters with their subordinate mobile intercept companies;
- c. The communication intelligence platoons at division headquarters;
- d. One single intercept replacement company, in which only basic RI training could be given.

The Polish campaign fully revealed the difficulties involved in employing intercept units in mobile operations. No satisfactory solution

~~CONFIDENTIAL~~~~Security Information~~

~~CONFIDENTIAL~~~~Security Information~~MS # P-038
App. I

-171-

had been found to the problems of transmitting intercepts obtained by long-range intelligence from the intercept company to the evaluation center and of dispatching urgent information from the evaluation center to the headquarters concerned. Essential elements of information gathered by the intercept companies often reached only the army commanders in whose territory they were operating and not the evaluation center. The activities of the Evaluation Control Center and the fixed intercept stations on the one hand, and the evaluation centers and mobile intercept companies on the other were not co-ordinated. In the matter of efficiency and operating procedures certain differences between individual units became apparent. In the interests of a consistent, well-balanced intelligence picture these differences had to be ironed out. Once again the communication intelligence platoons at division headquarters were unable to obtain any satisfactory results. The Evaluation Control Center at OKH, which had remained in Berlin, had not succeeded in establishing uniformity among all the intercept units.

During the concentration of forces in the West, the positions of Commander of Intercept Troops West and East were therefore created. They were in charge of the evaluation centers, fixed intercept stations, and mobile intercept companies within their sphere of interest. Their newly-formed staffs were given the mission of standardizing the operating procedures of all subordinate units.

For the campaign against Denmark and Norway only one intercept platoon was transferred from the units deployed in the West.

~~CONFIDENTIAL~~~~Security Information~~

~~CONFIDENTIAL~~~~Security Information~~LS # P-038
App. I

-172-

Shortly before the beginning of the Campaign in the West another step was taken in the direction of decentralization. The positions of Commander of Intercept Troops West and East were abolished. Each army group headquarters was assigned its own commander of intercept troops and evaluation center. They were responsible for the intercept companies, fixed intercept stations, including those which had been made mobile temporarily (initially only the Euskirchen station) within the army group area. During the campaign against France this organizational change proved entirely satisfactory with regard to long-range intelligence, whereas tactical intelligence could achieve only limited results. Orders issued by one army group, consolidating the RI platoons of its divisions into one company came too late to become effective.

During intercept operations against Great Britain in 1940-41 the first attempts were made to employ mobile D/F units in plotting the sources of short-wave signals.

One intercept platoon, subsequently reinforced to form a company, was assigned to the German Africa Corps in March 1941.

Similar arrangements were made for the German campaign in the Balkans.

For the campaign against the Soviet Union each of the three army group headquarters was assigned a commander of intercept troops, who was in charge of two or three mobile intercept companies. The new army group, which was committed in 1942 on the southern wing for the offensive into the Caucasus and Kuban areas, had its own intercept units under a responsible commander. During the same year the first fixed Adcock D/F net was

~~CONFIDENTIAL~~~~Security Information~~

~~CONFIDENTIAL~~~~Security Information~~

LS # P-038

-173-

App. I

established along the Kranz-Rzeszów base line. It covered the entire Russian front and remained under the jurisdiction of the Evaluation Control Center.

In 1942, during the Russian campaign, the plan to organized distinctive short-range intercept units was finally realized. At the same time, the intercept service was redesignated communication intelligence.

From the personnel and equipment of the communication intelligence platoons, which were reduced to combat intelligence teams, each army formed one short-range intelligence company, which was placed under a newly-established communication intelligence battalion staff. This staff in turn was subordinate to the commander of the communication intelligence regiment at army group headquarters. To the latter's staff were assigned one communication intelligence platoon for special intercept operations and one communication section equipped with short-wave transmitters and teletype terminals. No changes were made with regard to the evaluation center.

The T/O of the short-range communication intelligence company called for 7 officers and 300 enlisted men, who were equipped with improved wire intercept apparatus and radio receivers -- primarily for intercepting phone traffic on frequencies above 3,000 kc. -- as well as portable short-wave, short-range D/F equipment which had been recently developed. The T/O specifically included an evaluation team, a messenger section, a wire (communication) team, a radio (communication) team, a radio intercept platoon, three intercept-L/F platoons, and a wire intercept platoon. The radio intercept platoon had one radio (communication) team and three

~~CONFIDENTIAL~~~~Security Information~~

~~CONFIDENTIAL~~
~~Security Information~~

LS # P-038
App. I

-174-

intercept teams. The intercept-D/F platoons comprised one evaluation team, one radio (communication) team, three intercept teams, and three D/F teams. The wire intercept platoon consisted of six intercept teams.

The standing operating procedure was as follows: Disregarding corps and division boundaries, the company usually stationed its evaluation center near a corps command post, together with the radio intercept platoon which was equipped with about thirty receivers but had no D/F teams. The principal mission of this platoon was to bridge the gap between long and short-range intercept operations.

The three intercept-D/F platoons, which were equipped with fifteen receivers and three D/F sets each, were moved as far forward as the situation permitted in order to be within effective ground wave range of the enemy field sets. The D/F base line of the individual platoons was not to exceed six to ten miles. Moreover, each platoon had its own small evaluation unit staffed with cryptographers, who did not engage in cryptanalysis proper but decrypted messages with the help of complete sets of cryptanalytical solutions. Intercepts made by advance platoons were to be reported without delay directly to the staffs and units concerned, after which the data was reported to the intercept company headquarters.

The wire intercept platoon employed its teams either as a unit, or individually, or as members of mixed units with the mission of uncovering new possibilities.

The intercepts obtained by all platoons were compiled by the company evaluation center, and the information was transmitted to communication

~~CONFIDENTIAL~~
~~Security Information~~

~~CONFIDENTIAL~~
~~Security Information~~

LS # P-038
App. I

-175-

intelligence battalion headquarters at army. All available means of communication were used for disseminating the information within the army area, including the higher-echelon and tactical nets, as well as the intercept company's own communication facilities.

Although this was contrary to their original mission, elements of the short-range intercept companies soon had to be diverted to combatting partisans and radio agents in the rear areas, since only these companies had equipment suitable for locating the enemy stations. In order not to jeopardize tactical short-range intercept operations at the front, special radio counterintelligence ^{*} units were formed for the rear areas and put

*

[Tr: This term is used to render the German Funkabwehr, for which there is apparently no suitable English equivalent. The author uses this expression to refer to radio intercept operations against partisans and enemy agents in rear areas, the zone of interior, and occupied countries.]

under OKW jurisdiction.

The fixed intercept stations had either been transferred from their prewar locations to the theaters of operation -- to Warsaw, The Hague, Strasbourg, Bordeaux, and Athens -- or else disbanded and used for the activation of mobile long-range intelligence companies. The fixed stations at Husum and Euskirchen were the only ones to remain at their peacetime location. The Euskirchen station, which was temporarily motorized during the French campaign and had moved to Hardelot near Boulogne, later returned to Euskirchen, where it was chiefly engaged in very-long-range interception of United States traffic.

~~CONFIDENTIAL~~
~~Security Information~~

MS # P-038
App. I

-176-

The distribution of communication intelligence staffs and units after the reorganization was as follows: Serving OKH there was an Evaluation Control Center, a fixed intercept station, and a long-range D/F platoon. At army group level the Commander of Intercept Troops had under his control an evaluation center, a fixed intercept station, a long-range intercept company, and an intercept platoon (at army group headquarters). The communication intelligence battalion staff at army headquarters controlled a long-range intercept company within the army area and a short-range company within the subordinate corps areas. A short-range intercept team was assigned to each division but was not in the chain of command, which began at OKH.

The development of radio-guided, rocket-propelled missiles in 1944 led to the formation of a special radio intelligence unit. An intercept company was organized within the radio battalion of the Long-Distance Rocket Division to receive the impulse waves of V-2 missiles for the purpose of measuring their velocity, providing release of the propellant cut-off, and perfecting control by pilot beam. In addition, the missile was observed in flight by radar control and the impact point was ascertained by radio D/F. However, the most important mission of this company was to determine the location of any enemy station that attempted to jam the impulse waves of the missiles.

The fixed intercept station at Husum discontinued its long-range activities at this time and assumed responsibility for the systematic

~~CONFIDENTIAL~~~~Security Information~~MS # P-038
App. I

-177-

observation of all impulse radio signals which could be picked up at that point.

Soon after the beginning of the Allied invasion of France and during the German withdrawal from western Europe, it became evident that the German communication intelligence units employed in this area were too weak. Army Groups G in southern France and H in the Netherlands had no communication intelligence commanders, and most of the army headquarters were without communication intelligence battalions, such as the ones which were available to their counterparts in Russia, where they had proved very effective. The weakness of the German communication intelligence units in the West prior to the Allied invasion could be explained as the price which had to be paid for building up the more urgently-needed intelligence organization in the East, but now that the western European front was no longer static immediate steps had to be taken to remedy this situation. In the autumn of 1944, the Army Chief of Signal Communication transferred a number of communication intelligence headquarters and companies from the Russian front to western Europe in order to support and strengthen communication intelligence in this critical area. They were placed under a "Senior Commander of Communication Intelligence" attached to OB West.

In addition, the position of General of Communication Intelligence was created in the autumn of 1944 under the Chief of Army Signal Communication. Aside from being a tribute to the steadily increasing importance of communication intelligence in warfare, the creation of this position

~~CONFIDENTIAL~~~~Security Information~~

~~CONFIDENTIAL~~~~Security Information~~

MS # P-038

-178-

App. I

served the purpose of raising the general standards of performance. The newly-appointed general and his staff were to co-ordinate communication intelligence activities, accelerate the exchange of essential information, and bring about a steady improvement in the over-all efficiency of operations by assuming control over training, personnel assignments, and the development of new equipment. The General of Communication Intelligence was placed in charge of the Communication Intelligence Control Center, which collected, processed, and disseminated information of importance destined for Hitler, OKW, and the Eastern and Western Intelligence Branches of OKH.

Centralized control over short-range intelligence performed by individual companies provided the corps and army headquarters with more reliable and comprehensive tactical information about the enemy capabilities than had formerly been obtained by decentralized operations at division level. However, this information reached the division headquarters too late to be useful in the conduct of operations. Even with the quickest processing methods, the new and more extensive organization functioned in such a way that too much time was required to relay information through the tactical evaluation center to the combat sector concerned. In view of the increase in the number of enemy sets using voice and the multitude of openings their users granted to the Germans, the front-line divisions decided to organize improvised short-range RI teams with the personnel and equipment of their own division signal battalions. These teams soon scored astounding successes against enemy voice traffic. All that was needed

~~CONFIDENTIAL~~~~Security Information~~

~~CONFIDENTIAL~~~~Security Information~~MS # P-038
App. I

-179-

to achieve such success were a few radiomen with portable receivers, some good linguists, and an opponent who, whenever the fighting amounted to more than just position warfare, grew so excited that he committed breaches of radio discipline which could be immediately exploited by German artillery fire. This was true of the Russians, the British, and the Americans in equal measure.

In most instances, infantry divisions employed six to eight receivers. Some armored divisions intercepted Russian voice communications even while moving to new combat posts.

For the sake of completeness mention should also be made of the operations of those wire intercept teams which at first belonged to the short-range communication intelligence platoons of the divisions and were subsequently part of the short-range intelligence companies. They were finally returned to divisional jurisdiction and moved up to the forward-most line. In position warfare against the Russians these teams produced valuable information at certain points, especially when, during a withdrawal to a new position, they were able to leave behind ground intercept circuits in the area that the enemy was about to occupy. In such instances they obtained information from enemy conversations dealing with intended operations and movements, thus enabling the combat forces to take immediate countermeasures. On the whole, however, the employment of such teams was impractical, because it required a large number of highly-skilled personnel without furnishing commensurate results, either qualitatively or quantitatively. Whenever the situation called for or permitted the use of such teams, they could always be improvised with the assistance of a few

~~CONFIDENTIAL~~~~Security Information~~

~~CONFIDENTIAL~~~~Security Information~~MS # P-039
App. I

-180-

linguists. This was particularly true in cases where the Germans were able to tap lines which the enemy continued to use before he finally imposed security measures. A few such instances occurred also during World War II, including occasional, briefly-successful attempts to deceive the other party on the line and thereby obtain answers to questions. To illustrate this, one might mention that the Germans were able to exploit an opportunity for tapping French telephone lines in the outpost area of the West Wall and listen to the conversations of an outpost-guard. In a more significant case they tapped an inadequately protected trunk circuit out of Warsaw during the siege of that city in 1939, and intercepted the conversations between the Polish commander and his subordinates in the different defense sectors.

No wire intercept teams were employed during the German retreat from western Europe. On the other hand, during the confusion of the final weeks of the war the Germans, fighting within their own borders, made extensive use of what might be called telephone intelligence. Postal telephone workers, public officials, and private persons were requested to give information about the enemy in occupied or contested areas over civilian long-distance telephone lines. Whereas in eastern Germany the Russian armored points were immediately followed by signal troops, which occupied telephone exchanges, thus gaining control of the circuits, the Americans were quite derelict in taking over phone facilities promptly. For this reason the Germans were usually able to obtain information about American movements during a period of several hours after a city or town had been

~~CONFIDENTIAL~~~~Security Information~~

~~CONFIDENTIAL~~
~~Security Information~~MS # P-038
App. I

-181-

captured. The fact that this carelessness did not result in heavy casualties was attributable solely to the weakening of German resistance.

The actual strength figures of communication intelligence personnel in the German Army at the end of the war in 1945 were approximately as follows:

General of Communication Intelligence, including his staff) and the Communication Intelligence Control Center)	250
6 commanders of communication intelligence, with their staffs and evaluation centers)	1,200
10 communication intelligence battalion staffs		500
5 fixed intercept stations		750
10 long-range companies		3,500
15 short-range companies		4,500
Army personnel employed in radio counterintelligence units and the Cryptographic Branch of OKW		<u>1,300</u>
Total:		<u><u>12,000</u></u>

These figures do not include the short-range teams directly subordinate to division headquarters, the numerous female auxiliaries who were employed as radio operators with rear echelon units, the communication intelligence replacement battalion at Frankfurt am Main, the translator replacement battalion at Weissen, the provisional instruction unit at the Army Signal School in Halle, and the communication intelligence training company.

~~CONFIDENTIAL~~
~~Security Information~~

~~CONFIDENTIAL~~
~~Security Information~~

MS # P-038

-182-

Appendix II

Survey of the Technological Evolution of German Radio

Intelligence

In World War II a great number of the successes scored by German radio intelligence could be attributed to the effectiveness of its special equipment.

During World War I the intercept service used general-purpose receiving sets. When atmospheric interference was not too great radio intercept efforts were successful, because damped-wave transmission, using high power, was customary at that time. The Germans had large, highly-sensitive goniometers, which were ideally suited to position warfare. The transition to undamped-wave transmission -- with its high selectivity -- toward the end of the war made it necessary to adopt different methods.

During the first years of its existence the Reichwehr used commercial-type receivers and direction finders, which, however, proved inadequate for both active and passive military radio operations. Special research led to improvements in general-purpose equipment, which continued in use for intercept operations.

Not until 1937 was it definitely decided that the intercept service should develop some equipment of its own. Intercept receivers had to have a sufficiently-wide frequency range and meet the special requirements peculiar to intercept activity. For the purpose of instantaneous recognition, rapid recording, speedy direction finding, and mechanical deciphering, the intercept service needed equipment of maximum mechanical sturdiness

~~CONFIDENTIAL~~
~~Security Information~~

~~CONFIDENTIAL~~~~Security Information~~

MS # P-038
App. II

-183-

which would be weatherproof under arctic and tropical conditions. Moreover, this equipment had to be reliable and easy to install and operate. The frequency tuning of the receivers had to correspond to that of the direction finders, and it was necessary that both have sufficient output.

To satisfy these requirements the Signal Equipment Branch of the Army Ordnance Office added to the wire and radio equipment sections a special section for the development of radio and wire intercept and cryptanalytic equipment. This section developed a series of highly-effective radio intercept receivers covering the frequencies to be observed. The best model, which had a frequency range of 10 kc. - 150 Mc., was ready for issue in mid-1939. The quality of these sets was acknowledged in British scientific publications in 1942, after several of these receivers had been captured at El Alamein.

In contrast to the military establishments of other nations the German Army made but little use of the unreliable short waves from 10 to 100 meters. At a very early date German armor took the bold step of adopting ultrashort-wave equipment, which proved very satisfactory in inter-tank communication, since, contrary to predictions, the propagation of these waves was not limited to direct line of sight. Intermediate headquarters generally used medium (100 - 300 meters) wave sets, while higher-echelon headquarters employed the long wavelengths (300 - 1,000 meters).

Hans all over the world have taken advantage of the wide propagation characteristics of the short waves. Coverage of great distances with a small amount of power was a commonplace occurrence. It was therefore

~~CONFIDENTIAL~~~~Security Information~~

~~CONFIDENTIAL~~
~~Security Information~~

MS # P-038
App. II

-184-

logical that many countries should use these waves also for military purposes. However, short-wave signals have a great disadvantage in that they fluctuate and are extremely unreliable when received in the skip zone whose limits are difficult to determine. The sky wave component of a signal can be counted on with accuracy only after extensive observation of its behavior during different seasons and times of the day.

These considerations had to be taken into account in developing intercept receivers and direction finders. The interception of short-wave signals required two fairly complicated types of direction finders: a short-range set for ground-wave reception and a long-range one, which was initially designated the "Adcock direction finder" after its inventor. The latter was used along a wide base line; for example, in Russia it operated along a 400-mile base line between Rzeszów (Galicia) and Kranz (East Prussia), and in the Mediterranean area against the British Eighth Army in North Africa along a 750-mile base line (Tripoli and Crete). During the winter war in Finland reception of short-wave signals from Finland was better in Galicia than in East Prussia. Likewise, Allied traffic following the landings in French North Africa was, surprisingly enough, heard particularly clearly in northern France.

In addition to developing these highly-intricate direction finders, the intercept service brought out receiving equipment designed to handle radioteletype, multiplex, facsimile, and sound-recorded transmission. For the development of mechanical equipment for use in cryptanalysis a special research unit was created. Technical and organizational details

~~CONFIDENTIAL~~
~~Security Information~~

~~CONFIDENTIAL~~

~~Security Information~~

MS # P-038
App. II

-185-

of this evolution, which received strong impetus in the course of the war,
are given in Appendix VII.

~~CONFIDENTIAL~~

~~Security Information~~

~~CONFIDENTIAL~~~~Security Information~~

MS # P-038

-186-

Appendix III

Basic Elements of Radio Intelligence

This account is based on the operating procedure of an intercept company. Fixed intercept stations, such as the subsequently established long-range and short-range communication intelligence companies and the evaluation centers farther to the rear, all operated in similar fashion.

Numerous alternatives by which the operating procedure may be changed through the transfer of units and the building up of points of main effort in accordance with the opposing radio traffic have not been taken into consideration in the following.

1. Interception

The personnel of the intercept company could operate thirty-six receivers under normal conditions or twenty-four on an around-the-clock schedule. On the basis of the tactical situation and the intercept mission assigned it was usually possible to determine the radio sets and the channels that would be used by the enemy units (armored, infantry, or artillery elements, reconnaissance planes, or higher-echelon headquarters) which were to be observed. The less information that was available regarding the potential enemy traffic, the more channels there were which had to be guarded. Until he was given more specific instructions, the individual intercept operator had a certain portion of the spectrum to guard. He had to be able to identify the particular traffic in which the German Command was interested and to disregard the rest. For this purpose the operator had to have a comprehensive knowledge of the military and non-

~~CONFIDENTIAL~~~~Security Information~~

~~CONFIDENTIAL~~~~Security Information~~MS # P-038
App. III

-187-

military radio communication services of the various nations involved, including call signs and abbreviations. When they received their particular assignments, the operators were given all pertinent information based on previous observation by other RI units and on peacetime experience.

Intercepted enemy messages were then recorded and the call sign and type of message were determined from the heading, authenticator, and group structure. If an enemy net used two or more frequencies then these had to be determined, frequently in co-operation with another intercept operator, who would be tuning across the band in which the still-unidentified net stations were likely to be found. Then bearings had to be taken by direction finders in order to make sure that the traffic singled out by the operator originated from the area which he was assigned to cover.

After all the net stations had been identified, specific frequencies were assigned to individual operators. Thereupon, the operator was supposed to intercept all the traffic on that frequency, to note all call signs used and references to links with higher headquarters, to record any change of frequency or call signs, and finally to copy or record accurately all messages transmitted. Several D/F teams were used to determine the exact location of the stations from which the traffic originated. A close check had to be kept on the volume of traffic and any special characteristics, such as, for example, changes in signal strength, which would indicate some unit or command post movement. In such instances new bearings had to be taken to ascertain whether the station was operating from a different location. Where traffic was handled by just two stations on a single frequency,

~~CONFIDENTIAL~~~~Security Information~~

~~CONFIDENTIAL~~~~Security Information~~MS # P-038
App. III

-168-

in the case of which call signs were usually omitted, the beginning and ending time of each transmission had to be recorded, so that the stations could be constantly distinguished from each other for purposes of accurate D/F results. Attention had to be paid to relay messages, whose interception made it possible to discover the interrelationship between one specific link and others. When intercepting net traffic, the operator had to identify every participating station, including the net control station, and its relation, if any, to other links.

Moreover, the operator had to watch out for possible errors and characteristic traits in the technique of the enemy radio operators. Their disappearance and subsequent reappearance at some other point often indicated the relief or transfer of the entire unit to which the operator belonged. To accomplish such a variety of difficult tasks the intercept operator had to be thoroughly trained. He had to be able to receive an average of 120 characters per minute. In addition, he had to be familiar with enemy radio procedures, so that he could observe traffic without particular strain. Only then was he able to recognize peculiarities and errors, and record in full all conversations, plain-text messages, operating signals, and abbreviations.

In the performance of his duty the operator made out an intercept report. This was a form on which he entered all details pertaining to station identification, frequencies, message headings, and chronological data. The message proper was recorded on a special intercept form.

The officer or senior noncommissioned officer, who was in charge of

~~CONFIDENTIAL~~~~Security Information~~

~~CONFIDENTIAL~~~~Security Information~~MS # P-038
App. III

-189-

an intercept unit, had to arrange the work shifts and establish priorities for the observation of channels on the basis of requests received from the evaluation center. He was also in charge of the D/F teams and had to keep a traffic chart. On this diagram he merely showed frequencies, call signs, and transmission times without entering any geographical or tactical data. The completed intercept reports and message texts were forwarded to the evaluation center. Any peculiarities or changes in the general radio picture had to be reported to the latter immediately.

2. Direction Finding

The mission of the D/F units was to determine the location of enemy stations which had been identified and were being observed by the intercept operators.

The operating site chosen by a D/F unit had to be favorable for radio reception and have a minimum magnetic declination. Each D/F team included two operators, one of whom received messages from other D/F teams, while the second acted as intercept operator, observing traffic on which he reported to his NCS.

In addition to their training in intercepting, the D/F operators had to acquire adeptness in rotating the loop antenna to the point of minimum volume, ascertaining the width of this band of minimum response, and computing the exact azimuth from the marginal readings. Moreover, D/F operations had to be carried out with exceptional speed, since often only one or two call signs or an acknowledgement lasting a few seconds could be intercepted. Extreme care had to be exercised lest the evaluation

~~CONFIDENTIAL~~~~Security Information~~

~~CONFIDENTIAL~~
~~Security Information~~

NS # P-038
App. III

-190-

personnel be misled. Each operator used a report form on which he entered information regarding the time, frequency, call sign, and fragments of intercepted messages, as well as the azimuths obtained.

To dispatch D/F teams a transmitter at the intercept center was used. The operator stated the frequency and call sign of the station to be located and the number of the D/F team, so that the azimuth thus taken could be later confirmed by checking. If no teletype communication was available, the D/F data was forwarded to the evaluation center by radio.

3. Evaluation

The mission of the evaluation unit was to correlate the reports of the intercept and D/F units in order to obtain an accurate picture of enemy radio communication and to sum up the information in a radio situation report. To accomplish this mission each evaluation center was subdivided into five sections, namely the traffic, procedure, D/F, message, and final evaluation section. The first four sections were headed by noncommissioned officers, while an officer was in charge of final evaluation. The company commander was responsible for writing the radio situation report. Working in conjunction with the evaluation units was the cryptanalytic section, headed by another officer, which solved simple field ciphers that could be handled by the field-type equipment issued to the intercept companies. The data needed for current cryptanalytic operations was distributed by the Evaluation Control Center.

The individual sections were responsible for the following functions:

~~CONFIDENTIAL~~
~~Security Information~~

~~CONFIDENTIAL~~
~~Security Information~~

MS # P-038
App. III

-191-

The traffic evaluation section maintained the radio traffic chart and recorded all guarded frequencies, call signs, and prosigns on lists or index cards. This reference material helped to uncover any organizational changes on the opposing side, such as the relief, transfer, or first appearance of units, and changes in frequencies and call signs. The stereotyped procedure used by the Russians often enabled the Germans to predict when individual enemy stations would change call signs and frequencies.

The procedure evaluation section identified net relationships on the basis of characteristics, such as special operating signals, abbreviations, peculiarities in message texts, and the idiosyncrasies of certain operators. This section observed the traffic of the various nets and registered the results on diagrams. In addition, it identified the net control stations from such details as intervals between messages, time signals, collective calls, and identical messages and acknowledgements transmitted on more than one frequency.

The D/F evaluation section had to summarize the reports submitted by the D/F teams and make entries on the D/F chart. From these findings it was possible to draw conclusions concerning the location of the enemy radio stations. By combining this information with that produced by the traffic and procedure evaluation sections, one could determine the organizational structure of the enemy units, since the establishment of radio stations at too great a distance from the headquarters which they served was impractical. Any changes in the location of enemy forces, that is, any tactical

~~CONFIDENTIAL~~
~~Security Information~~

MS # P-038
App. III

-192-

movements, had to be recognized without delay and reported immediately.

As the initial step in setting up operations, the D/F evaluation section had to provide the teams with data taken from the chart of magnetic declination. These corrective factors were applied by the teams, thus obviating the necessity of recalculating each figure at the evaluation center. One of the functions of the section was to compute the bearing error of each team with regard to direction and frequency and to make due allowance for them in estimating each fix. By this means the assumed location of a radio station under observation -- theoretically at the intersection of the bisectors of the angle of the error triangle -- could more nearly coincide with its actual position. In co-operation with the intercept control station, the D/F evaluation section was responsible for supervising the D/F teams, for repeating operations whose results were unsatisfactory, and for continuous plotting of stations which were believed to have changed their location. A steady flow of D/F reports originating at the teams arrived at the section ^{by} wire or radio and eventually in writing and had to be carefully processed. The azimuths were transferred to overlays on 1:100,000 or 1:50,000-scale maps. In plotting over extremely long distances, the deviations due to the curvature of the earth had to be calculated and taken into account when the long, straight azimuth lines were transferred to the overlay. For this purpose a simplified method suitable for field operations was developed.

In addition to messages in clear text, the message evaluation section dealt chiefly with combat and supply messages which were partly encrypted

~~CONFIDENTIAL~~
~~Security Information~~

MS # P-038
App. III

-193-

by means of signal charts, brevity codes, and other code designations. The solution of fully encrypted texts was a function of the cryptographic Branch as explained in Appendix V. This branch provided the message evaluation section with the solutions to cryptosystems, so that subsequent messages, for which the same systems were used, could be solved on a local level. The message evaluation section maintained lists and index cards containing information on its interpretation of enemy code designations, as well as the names of officers, radio operators, and localities, and any unit designations which were occasionally intercepted in the clear. The purpose in gathering every little piece of information was to make the material readily available to the final evaluation section.

The final evaluation section collected the information obtained by the four other evaluation sections, checked it for accuracy and condensed it in the radio situation reports. In this process the personnel of the section "translated" the commonly-used radio operator's jargon into the kind of German which would be understandable to any general staff officer.

In the radio situation report any statement or data which could not be fully and reliably substantiated by evaluation results had to be specially designated as conjecture. But even conjectures had to be logical conclusions drawn from underlying facts. Imaginative speculations were strictly forbidden. The commander of the intercept company, who signed the radio situation report, fully realized that the information he had collected represented only a part of the intelligence picture. The overall estimate of the enemy situation was an Army General Staff function.

~~CONFIDENTIAL~~
~~Security Information~~

~~CONFIDENTIAL~~~~Security Information~~IS # P-038
App. III

-194-

The experience of German radio intelligence shows that the emphasis on the different types of evaluation fluctuated constantly in accordance with the ever-changing enemy radio procedures. To illustrate this point it might be mentioned that in Russia 75 percent of the communication intelligence results from higher-echelon nets were obtained from traffic and D/F evaluation and 25 percent from message evaluation. At the purely tactical level 95 percent of all information was derived from message evaluation. The Evaluation Control Center collected 50 percent of its intelligence from message evaluation and the other 50 percent from traffic and D/F evaluation.

~~CONFIDENTIAL~~~~Security Information~~

~~CONFIDENTIAL~~
~~Security Information~~

MS # P-038

-195-

Appendix IV

Radio Counterintelligence

(Based on a report by Lieutenant Colonel de Bary, director of German radio counterintelligence 1942 - 45.)

1. Amateur Radio Activity

In view of the similarity of radio systems in general, former peacetime hams constituted an important reservoir of potential radio intelligence agents and operators for the resistance movements. Amateur radio operations developed along widely differing lines in various countries. For example, at the request of the Reichswehr, the Weimar Republic prohibited amateur radio traffic in order to paralyze the illegal communication between the Communist party and Soviet Russia. In view of the conditions prevailing at that time, this decision was probably correct, even though it was instrumental in preventing an increase in the number of experienced radio operators. The Third Reich adhered to this policy which, although perhaps a mistaken one, can be explained by the fear of increased espionage activities.

It was quite different in the United States, which, unconcerned about such risks, encouraged amateur radio activities as a kind of sport. This policy had the advantage that the amateurs helped to advance technical developments and formed an ever-growing pool of experienced manpower. This wealth of technical experience and trained personnel gave the United States a head start in the design and production of radio equipment. Then it was suddenly confronted with the large-scale requirements of a

~~CONFIDENTIAL~~
~~Security Information~~

~~CONFIDENTIAL~~~~Security Information~~MS # P-038
App. IV

-196-

fighting war. However, this freedom of the air waves involved the risk that a ham might easily become a radio agent. Germany took advantage of this opportunity by recruiting radio agents in the United States and South America before the war; these continued to send messages to Germany after the war had started. The Germans collected valuable economic and political information from this source.

Great Britain took no chances with regard to the loyalty of its radio amateurs. The British Radio Amateur Association performed a loyalty check of its members and prevented any abuses. At the same time the British encouraged radio operations throughout the Empire.

Things were entirely different in the Soviet Union. There the Party retained firm control and encouraged amateur radio operations among its devoted members in order to make use of them in wartime as partisans and radio agents. Many hundreds of such experienced radio operators are probably available in the Iron Curtain countries today.

Nowadays the field of radio offers many opportunities for subversive activities. The most elaborate means are required to track them down. The doors stand wide open to espionage and subversion unless this "war of the air waves" can be won in peacetime.

2. Radio Agents in Occupied Territories

When German troops occupied Czechoslovakia and Poland in 1939, Norway, Denmark, the Netherlands, Belgium, and northern France in 1940, and the Balkans in 1941, it was impossible to prevent the formation of underground

~~CONFIDENTIAL~~~~Security Information~~

~~CONFIDENTIAL~~
~~Security Information~~

HS # P-038
App. IV

-197-

movements and resistance groups or interdict the activities of numerous agents equipped with radio sets. The mission of these agents was to discover military and economic secrets; those working for the Soviets were given the additional task of planting the seeds of subversion within the German armed forces and civilian population. The latter were able to contact the internal German resistance movement and secure its support.

Communication within the resistance groups and among agents was handled by courier, while, for reasons of speed and security, reports to the central control stations, and orders originating from them were sent almost exclusively by radio.

The most important of these central control stations was located near London and was used by the western European governments in exile, including those of Norway, Poland, Czechoslovakia, and the Balkan countries. Some of the agents worked through ^{the} British relay station in Cairo. Whereas all these activities were clearly differentiated according to nationality, a number of individuals who lived in different countries and sympathized with the Communist ideology co-operated with the central control station in Moscow.

The radio intercept branch of the German civilian police, which was responsible for locating unlicensed transmitters, was unable to cope with the increasing volume of these illegal communications. In view of the significance of these underground activities to the war effort, the Armed Forces decided to intervene in 1940 and proceeded to take energetic counteraction through their experienced radio intelligence organization,

~~CONFIDENTIAL~~
~~Security Information~~

~~CONFIDENTIAL~~

**ORGANIZATION OF RADIO COUNTERINTELLIGENCE
1941-1945**

MS No. P-038 Chart I App. 4

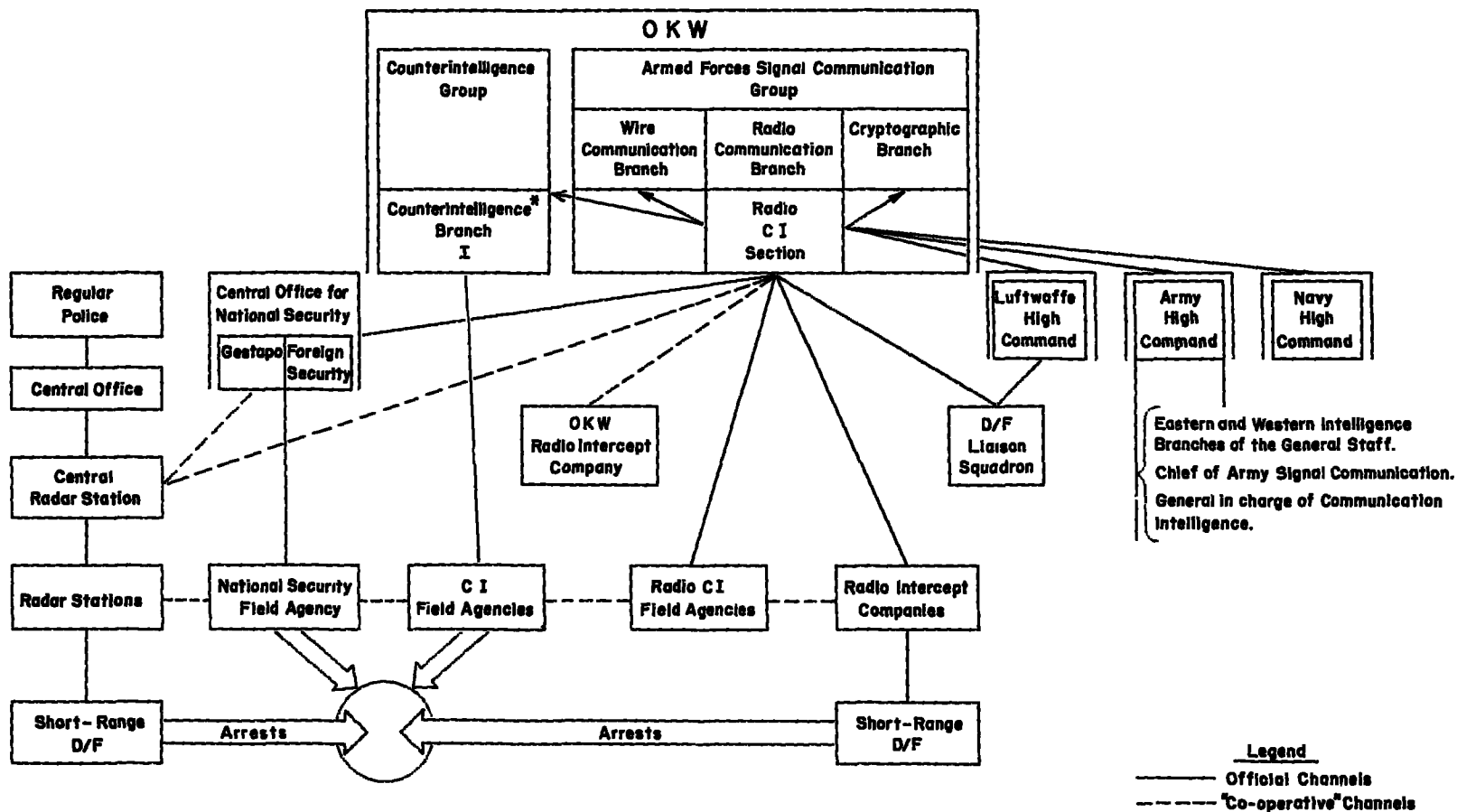

*Responsible for tracking down Enemy Radio Operations by Enemy Agents within Germany and in Occupied Territories.

~~CONFIDENTIAL~~

~~CONFIDENTIAL~~
~~Security Information~~

RADIO INTERCEPT COMPANY (MTZ) OPERATING PROCEDURE 1941-1942

MS No. P-038 Chart 2 App. 4

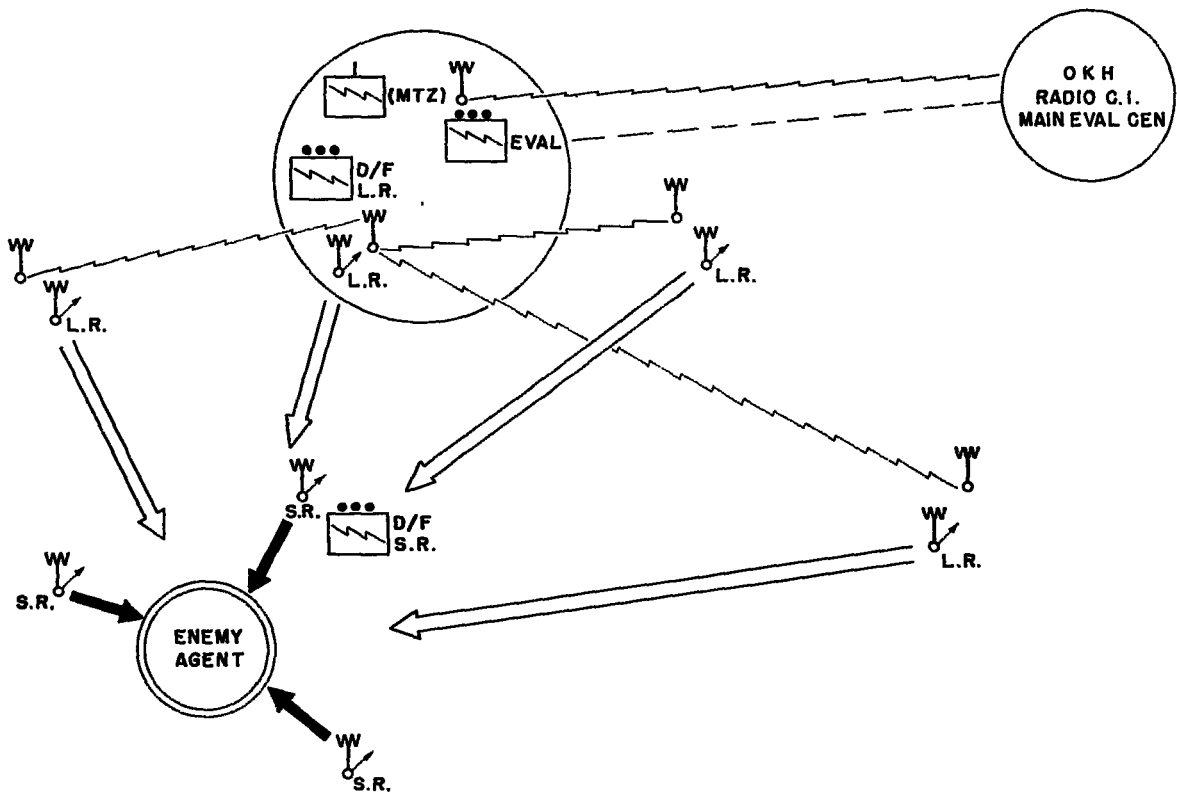

~~CONFIDENTIAL~~
~~Security Information~~

~~CONFIDENTIAL~~~~Security Information~~MS # P-038
App. IV

-198-

especially that of the Army. From the very beginning the military realized that they would have to employ different organizational and technical procedures than those currently used at the front.

3. Organization

Whereas the activities of German radio agents had always been directed by Counterintelligence Branch I, the Radio Counterintelligence Section was formed under the Radio Communication Branch of the Armed Forces Signal Communication Group, although this measure was administratively unsound. Up to the end of the war this confused organizational structure -- in which "co-operation" took the place of clearly-defined responsibility and in which the authority of the counterintelligence agencies, the civilian police, the Central Office of National Security, and the like overlapped constantly -- led to a waste of effort and constant jurisdictional conflicts. As a result many an enemy radio agent was able to escape, although his whereabouts had been definitely established by D/F.

The organizational structure of the German counterintelligence agencies is shown in Chart 1. Radio intercept companies were activated as operating agencies; their operating procedure is shown in Chart 2. The T/O of these companies (1941-44) included a motorcycle messenger section, an evaluation platoon, an intercept platoon (two sections), a long-range D/F platoon (four teams), and a short-range D/F platoon (three teams).

The Radio Counterintelligence Section employed roughly 2,000 officers, civilians, noncommissioned officers, enlisted men, and female auxiliaries, mostly from the Army and Luftwaffe. A similar number of people continued

~~CONFIDENTIAL~~~~Security Information~~

~~CONFIDENTIAL~~
Security Information

MS No. P-038 Chart 3 App.4

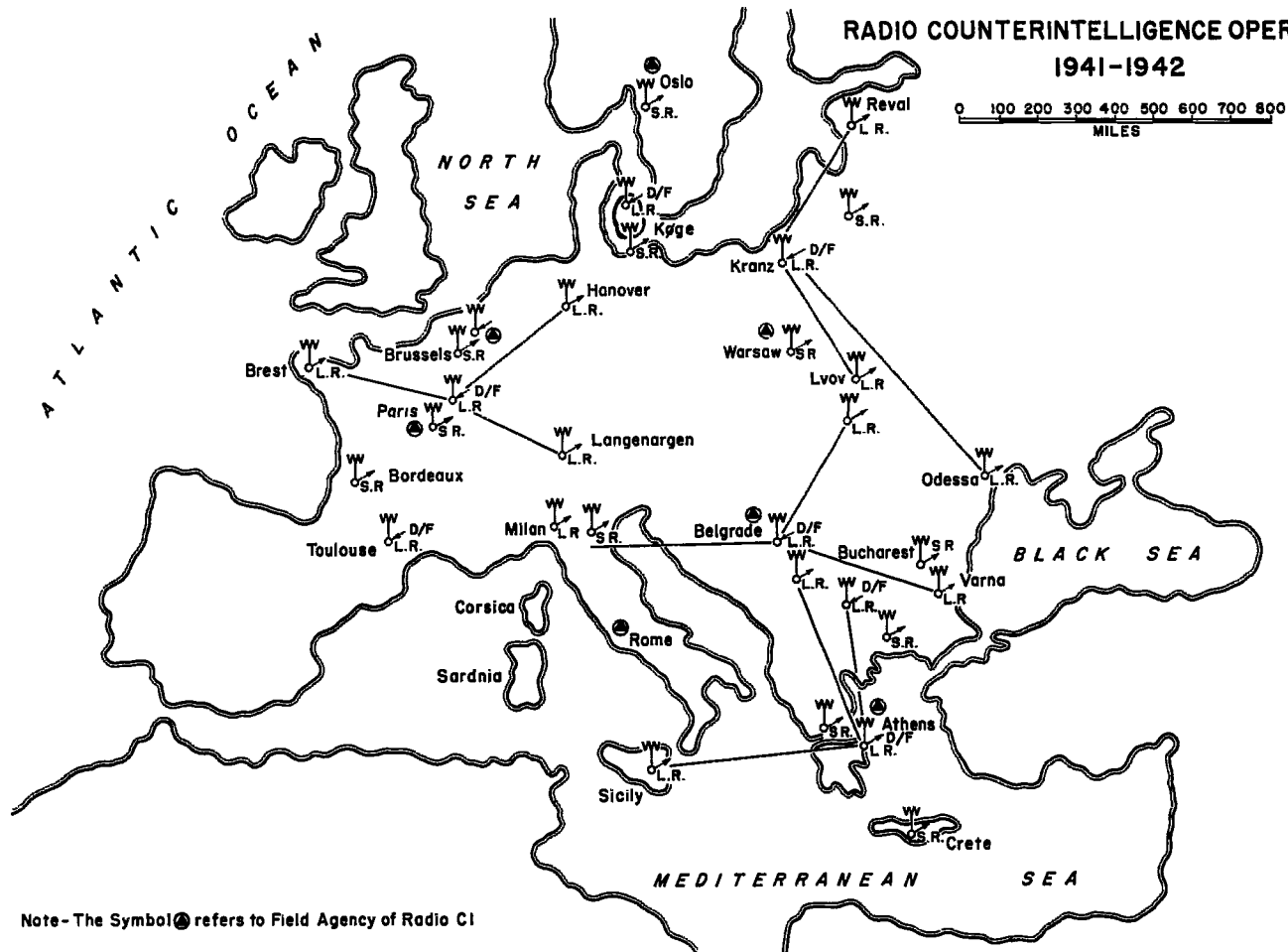
~~CONFIDENTIAL~~
Security Information

~~CONFIDENTIAL~~
~~Security Information~~

MS # P-038
App. IV

-199-

to serve with the radio intercept branch of the civilian police, which operated fixed radar stations in Berlin-Spandau, Tilsit, Brunswick, Cologne, Constance, Vienna, and Paris. These stations employed long-range D/F sets which were controlled over a special long-distance telephone circuit. A small number of short-range D/F teams under police jurisdiction covered Germany proper, occupied Poland, Norway, the Netherlands, and, in conjunction with the Armed Forces, the area around Paris. In all these territories, which were considered outside the theaters of operations proper, no military radio counterintelligence units were employed. The civilian police stubbornly opposed any military interference within the areas under its jurisdiction, and many an agent was thus able to escape. Chart 3 shows the areas in which military radio counterintelligence operated up to 1943.

The system of decentralization which was adhered to until that year and which corresponded to the system formerly employed in intercepting long and medium-wave traffic at the front, did not prove effective because of the difficulty in intercepting short-wave signals, the increasingly complex enemy radio systems, and the inevitable duplication of effort. Strict centralization was the answer to these problems. The radio intercept companies were relieved of their evaluation functions, which were then concentrated at an evaluation control center at Jueterbog. Radio intercept stations, staffed mainly by female signal auxiliaries and operating in conjunction with long-range D/F posts, were set up in Belgrade, Vienna, Paris, Hanover, K~~o~~ge, Kranz, Rome, Pulsnitz, Athens, and Jueterbog. In addition to these, three mobile short-range D/F companies were formed.

~~CONFIDENTIAL~~
~~Security Information~~

RADIO COUNTERINTELLIGENCE PROCEDURE INSTITUTED IN 1943

MS No. P-038 Chart 4 App. 4

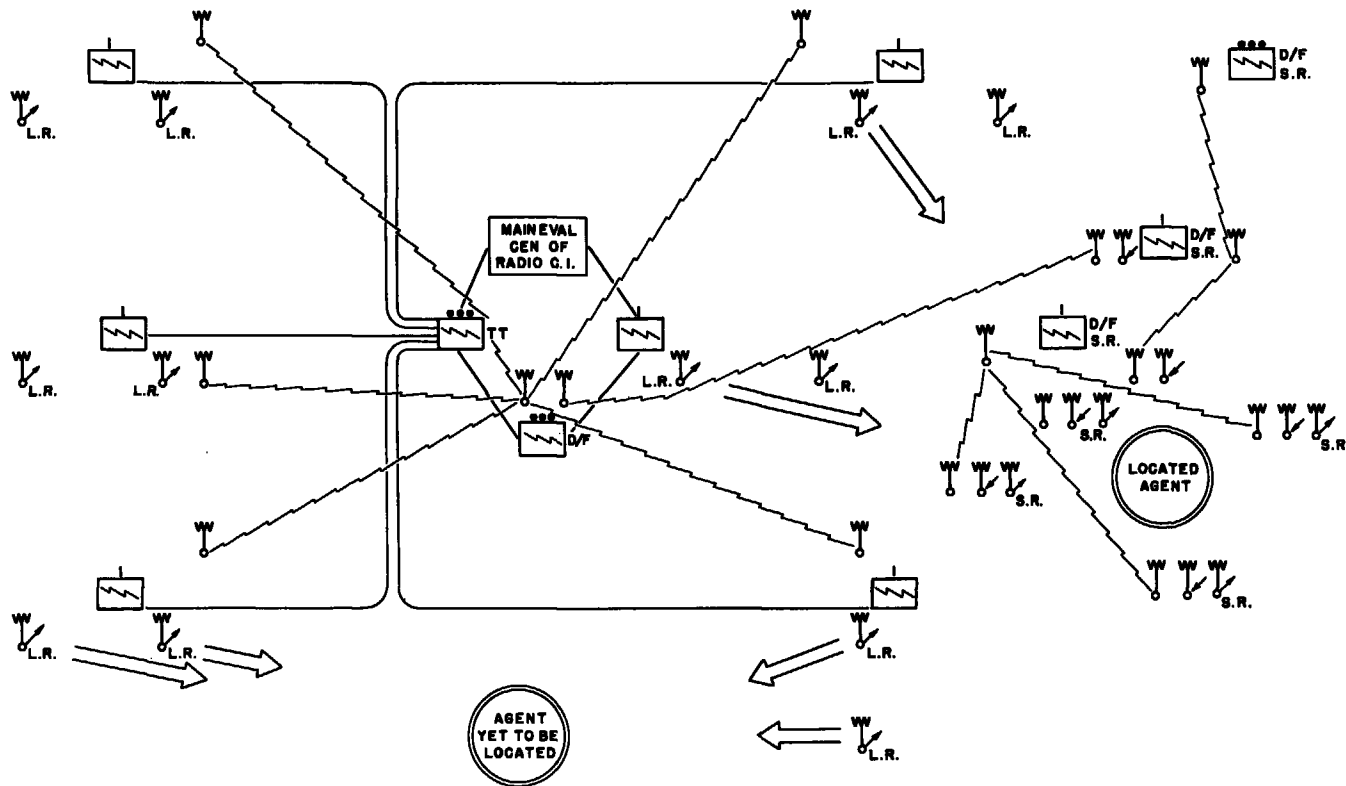

~~CONFIDENTIAL~~
Security Information

MS # P-038
App. IV

-200-

With this streamlined organization the Germans had less difficulty in coping with the rapidly increasing number of radio agents. Chart 4 indicates the structure of this centralized organization.

Intercept operations were no longer executed according to territorial jurisdiction, but were directed by the evaluation control center and carried out by those radio intercept stations which were best able to observe and plot short-wave transmissions. The last step in the process of reorganization, which would have been particularly commendable for military reasons, namely, the organization of radio counterintelligence into one regiment with subordinate battalions, corresponding to other military units, could not be effected in time.

4. Operating Procedure

Apart from the use of ultrashort waves by American agents, all the others operated with short-wave sets which, by taking advantage of sky-wave radiation, enabled their users to cover long distances with extremely small sets. Moreover, the skip zone offered the agents a certain amount of protection. According to the central control stations with which they communicated, the agents employed the frequencies which offered them the most favorable propagation at a particular time of day, taking into account the distance to be covered. This observation provided the Germans with clues for intercepting messages sent by enemy agents. The traffic of the governments in exile retained the national characteristics which were known from intercept operations previously carried out against the fighting forces of these countries. As the war continued, these characteristics

~~CONFIDENTIAL~~
~~Security Information~~

MS # P-038
App. IV

-201-

were progressively eliminated, the radio agents imitated more and more the German techniques and thus confronted German radio intelligence with formidable problems. Originally simple and easily observed, enemy systems became increasingly complicated the longer the war lasted. The enemy operated with several different traffic procedures, constantly changing call signs, and varying time schedules.

Often, three stations within a net took turns in transmitting a message, or else the stations changed their location each time they transmitted. Usually they were located in hotels or apartment developments in large cities, from which the operator had more than one avenue of escape and was able to watch for any approaching danger. In order to preclude the possibility of being deceived by fake radio traffic, whereby German RCI (radio counterintelligence) simulated the traffic of an enemy agent after he had been apprehended, the enemy introduced warning signals which were supposed to be transmitted at the very last moment. Having adapted itself to these peculiarities in technique, German RCI operations proceeded in the following sequence: Observation with or without net control station co-ordinating long-range D/F operations, evaluation, short-range interception, arrest of the agent, and final evaluation.

During the observation stage all previously identified friendly and foreign civilian and military radio nets were first eliminated with the aid of the so-called radio identification manual, and all other suspicious traffic was constantly observed and fixed. In western Europe intranet D/F communication was maintained largely by wire; in Russia, by

~~CONFIDENTIAL~~
~~Security Information~~

~~CONFIDENTIAL~~
~~Security Information~~

MS # P-038
App. IV

-202-

radio. It was organized in such a manner that several D/F teams were simultaneously notified in code within a maximum of ten seconds after initial interception which of the stations were to be plotted. The reply procedure, whereby the D/F data was forwarded, was equally fast. In order to gather additional material, previously identified agents and central control stations were kept under observation, and their bearings were occasionally checked in order to detect any changes in location that might have taken place.

Radio agents whose identity and location had been definitely established were kept under constant surveillance by at least two intercept stations in order to secure additional message texts.

The preliminary evaluation section at the intercept stations rechecked the intercepts in order to eliminate traffic of no interest. This section compiled daily D/F and intercept reports which were forwarded by teletype or radio to the evaluation control center in Jueterbog. The traffic analysis personnel at Jueterbog classified these reports according to the following six categories:

- a. Western net (Radio traffic of British and American agents)
- b. Eastern net (Radio traffic of Russian agents and spies)
- c. PS-net (Radio traffic of Polish and Czech agents)
- d. Southeastern net (British and Tito radio traffic in the Balkans)
- e. Illegal transmitters within Germany proper
- f. Unidentified nets.

The daily evaluation results, subdivided into two categories, were forwarded to all radio counterintelligence field agencies and to the

~~CONFIDENTIAL~~
~~Security Information~~

~~CONFIDENTIAL~~~~Security Information~~MS # P-038
App. IV

-203-

civilian police. In the first category was the so-called intercept locating data for agent-operated stations which were to be subjected to further observation prior to short-range scrutiny. In the second were the so-called observation results pertaining to stations which were under short-range surveillance and were to be subjected to further observation and eventual counteraction.

After the arrest of an agent, it was the task of message evaluation to solve previously intercepted messages with the help of the captured records. Cryptanalysis proper, as practiced in field radio intelligence, was not possible, since the worm systems used by the agents were based on certain books -- usually novels -- which provided the key.

Whenever a station operated by agents was considered ready for the short-range phase, personnel in civilian clothes with short-range D/F sets installed in motor vehicles (with no visible antenna) and in some instances in small airplanes, obtained a fix and encircled the suspected location. Usually miniature D/F sets attached to the operator's belt were used to determine the specific house and floor where the transmitter was located. Until the end of 1942 the time element was not so crucial, making it possible to call on the law-enforcement agencies to make the arrest. By 1943, however, the increasing caution of the agents compelled the intercept teams to take immediate and independent action after having definitely determined the location of a station, lest months of diligent observation should be in vain.

In this connection it is worth mentioning that the Germans on some occasions sustained serious losses of valuable specialist personnel.

~~CONFIDENTIAL~~~~Security Information~~

~~CONFIDENTIAL~~~~Security Information~~MS # P-038
App. IV

-204-

After successful arrests, experienced radio operators of the short-range intercept teams were occasionally called upon to transmit fake messages in an attempt to continue the apprehended agent's traffic. The arresting party had to catch the radio operator by surprise in the very act of transmitting in order to secure intact the maximum amount of traffic data which he was using. This data was submitted to the final evaluation section, where it was used to solve the extremely complex cryptograms previously transmitted by agents. By this procedure RCI obtained valuable information about intranet relationships, other agents, the ring leaders, and espionage activity in general.

5. Results

a. Against Agents

Working with its own equipment, RCI was able to effect about 30 direct arrests in 1941, 90 in 1942, 160 in 1943, and approximately 130 in 1944. In all, this amounted to some 410 cases, in about 20 percent of which the civilian police forces lent their assistance. Moreover, indirect arrests could be made on the basis of the information compiled by the final evaluation section. This source contributed approximately 140 additional cases during the same period. Thus, a total of 550 arrests stemming from RCI operations were effected in four years. The figures for arrests made by other counterintelligence agencies and the Central Office for National Security are not known.

In considering this figure of 550 arrests, however, one must mention the fact that there were at least 500 agent-operated stations which were

~~CONFIDENTIAL~~~~Security Information~~

~~CONFIDENTIAL~~~~Security Information~~

MS # P-038
App. IV

-205-

under observation and had even been located, but were never actually seized. There were at least twice as many suspected, unidentified agent-operated stations which had been intercepted at one time or another but whose exact number remained unknown. Chart 5 shows the approximate distribution of agent-operated stations intercepted as of the end of 1943.

One of the most striking facts is that not a single agent-operated station could be located in Germany proper. In spite of constant and intensified observation and short-range plotting in the Berlin area, near the Fuehrer's headquarters in East Prussia, in the Harz Mountains (V-2 testing range), all efforts were unrewarded, although there was definite proof that even top-level decisions and plans were being betrayed by persons located in the Fuehrer's headquarters.

Among the most notable achievements of radio counterintelligence, the "Red Trio" case deserves to be mentioned. After the arrest of a radio agent in Brussels fragments of messages were found which provided clues to the hiding places of the code books, which in turn were eventually found after a lengthy search throughout France and Belgium. The decryption of numerous messages revealed the existence of a pro-Russian resistance group whose members held important positions in German civilian and military agencies and which also included two members of the cryptanalysis section of the German radio counterintelligence service proper.

Details about this case are described in a novelistic manner in The Red Trio (Die Rote Kapelle) by W. F. Flicker (Vier Brueckenverlag, Hilden am Rhein, 1944), a so-called authentic, factual report, which actually

Body copy 25!

~~CONFIDENTIAL~~~~Security Information~~

~~CONFIDENTIAL~~~~Security Information~~

MS # P-038

Chart 5
Appendix IV

Agent-Operated Radio Stations Observed and Plotted in 1943-44

Location	Russian (Con- trolled from Moscow)	Polish (Con- trolled from London)	Czech	British (Con- trolled from London)	British (Con- trolled from Cairo)	US ultra- short wave	Total
In front of lines in France						15	15
Partisans behind German lines in Russia	140						140
Poland		20					20
Czecho- Slovakia			4* 2**				6
Norway	2			15			17
Denmark				4			4
Holland	2			20			22
Belgium	2			25			27
Paris	3	2		30			35
Western France				20			20
Southern France	3	8		50			61
Spain				10			10
Switzer- land	3	1					4

~~CONFIDENTIAL~~~~Security Information~~

~~CONFIDENTIAL~~~~Security Information~~

MS # P-038

Chart 5 (Continued)
Appendix IV

Location	Russian (Controlled from Moscow)	Polish (Controlled from London)	Czech	British (Controlled from London)	British (Controlled from Cairo)	US ultra-short wave	Total
Northern Italy				5	20		25
Southern Italy					8		8
Sardinia & Corsica				5			5
North Africa				5			5
Yugoslavia				5	25		30
Hungary	2	2			5		9
Romania	5	2			5		12
Bulgaria	3				6		9
Greece					20		20
Istanbul	2	2					4
Tiflis	2	2					4
Cairo		1			*** 1		2
Totals	169	40	6	189	90	15	509

* Controlled from London

** Controlled from Moscow

*** Alternate central control station

~~CONFIDENTIAL~~~~Security Information~~

~~CONFIDENTIAL~~~~Security Information~~MS # P-038
App. IV

-206-

contains numerous inaccuracies. In the publishers' introduction the author is described as the former chief of the German intercept service, which is a gross misrepresentation, since he actually held only a minor civilian position.

The Red Trio were three radio stations, which the Russian intelligence service operated in Switzerland and whose messages to Moscow were currently intercepted by the Germans. The contents of these messages revealed that traitors were inside the Fuehrer's headquarters proper, and that reports on strategic plans, secret weapons, and other top-secret matters were reaching these stations through channels which could never be determined.

Here is an example of the procedures which had to be used in radio counterintelligence: A Greek officer landed surreptitiously from a submarine in the vicinity of Athens in order to obtain military information. He attempted but failed to establish radio contact with the British central control station in Cairo. German radio counterintelligence intercepted his calls, sent a fake reply pretending to originate from the British central control station, and instructed the officer to switch to an emergency frequency. The officer was assigned a new mission with the promise that a submarine would pick him up at a specific place. The officer and four companions unsuspectingly climbed aboard a motor boat of the German Navy which was disguised as a submarine!

b. Against Partisans

The expansion of the theaters of war and the methods of combat used in the Balkans and Russia had the effect that communication intelli-

~~CONFIDENTIAL~~~~Security Information~~

~~CONFIDENTIAL~~~~Security Information~~LS # P-038
App. IV

-207-

gence was burdened with additional missions which initially had not been expected and which led to the organization of units employing special techniques.

In the occupied areas of western Europe and in Poland, the Germans had to observe and ferret out the constantly increasing number of radio agents, whereas in the Balkans and in the center of the Russian Front they had to deal with the partisans, who disrupted the lines of communications in the rear areas and who formed combat units of considerable strength which obstructed troop movements and interfered with the German withdrawals in 1944. They, too, had to be observed and neutralized.

The radio communication nets which enemy agents and partisans built up behind the German front were characterized by procedures which differed from those of the regular field units and therefore had to be counteracted by new intelligence procedures.

In 1943 on the Russian Front, a commander of communication intelligence with several intercept companies, including two Hungarian ones, and one evaluation center, was given the mission of observing enemy radio communication behind the German lines, whereas in the Balkans no special units were committed beyond those performing current operations against the front. The radio techniques used by the partisans in the Balkans resembled those employed in field radio traffic, while the Russian partisans operated in the same manner as radio agents.

Partisan radio traffic was intercepted for the double purpose of gathering information for anti-partisan warfare and for obtaining insight

~~CONFIDENTIAL~~~~Security Information~~

~~CONFIDENTIAL~~~~Security Information~~MS # P-039
App. IV

-208-

into the enemy's over-all strategy as expressed by the missions and movement orders transmitted to partisans.

aa. The Soviet Union

Whereas in the Ukraine and in the former Baltic states the partisans were of minor importance until 1941, they went into action in the extensive wooded swamps behind Army Group Center in White Russia, in the Pripyat Marshes, and on both banks of the Dnepr and Desna as early as the winter of 1941-42. They constituted a plague with which all rear-area headquarters, supply, transportation, and signal units had to contend every day.

At first the partisan units were improvised by communist fanatics and individual officers who recruited able-bodied men, women, and children of the civilian population and countless Red Army soldiers whom the rapidly advancing German combat forces had left behind unnoticed during 1941. On 3 July 1941 Stalin proclaimed over the radio:

"In the areas occupied by the enemy we must organize partisan detachments to fight the invader. We must extend the partisan war everywhere for the purpose of blowing up bridges and roads, damaging telephone and telegraph lines, and setting fire to forests, warehouses, and rolling stock. In the lost territories we must make life unbearable for the enemy and all their collaborators; we must pursue and destroy them step by step and frustrate all their activities. During withdrawals all valuable property that cannot be taken along must be destroyed without exception."

These bands soon developed into formidable, well-trained units.

Radio communication became increasingly important for giving them missions

~~CONFIDENTIAL~~~~Security Information~~

~~CONFIDENTIAL~~~~Security Information~~MS # P-038
App. IV

-209-

and receiving their reports and requests for supplies. Especially selected men and women were given excellent training in special radio communication schools. Radio operators jumped by parachute into the areas assigned to them, or else landed on partisan airfields with short-wave sets the size of a cigar box. Their radio communication with the army group headquarters, and more often with Moscow, adhered to standing procedures and were far superior to those of the ordinary field radio operator. Their radio discipline and cryptosystems were better. Finally, these communications were difficult to intercept because partisan operators made their messages very brief and changed their procedure frequently. The techniques of partisan radio operations were constantly improved and their communications thus became more difficult to intercept. Employment of the short wave-lengths caused the usual difficulties in reception and in D/F operations.

The increase in organized raids and surprise attacks upon individual vehicles, convoys, or towns, demolitions of railway tracks, and interruptions of telephone and teletype lines called for energetic punitive measures which were beyond the scope of the security detachments, which consisted of second-rate troops, police forces, and Hungarian units. During the autumn of 1943 a monthly average of 2,000 poles and 300 cables were cut down or demolished along the line routes which the two signal regiments of Army Group Center maintained between army group headquarters, the four armies, and the rear areas. Casualties among the maintenance personnel were correspondingly high. The army communication intelligence units observed the partisan traffic behind their front and gathered information

~~CONFIDENTIAL~~~~Security Information~~

~~CONFIDENTIAL~~~~Security Information~~MS # P-038
App. IV

-210-

about the hideouts, conduct of operations, and strength of the partisan units, as well as about how they were kept supplied with weapons, sabotage equipment, and rations. The results were of local significance and provided basic information for countermeasures. In some instances it was possible to track down partisan groups by employing short-range D/F teams. Occasionally the Germans succeeded in deceiving Russian aircraft loaded with supplies for the partisans with fake radio and light signals, thus causing them to drop their cargoes or land at the wrong point.

By committing companies, regiments, and even divisions, important lines of communications were cleared of partisans and troublesome areas were mopped up, but the Germans were never able to eradicate this danger from the extensive areas which had poor road facilities.

The insecurity in the rear areas was so serious that Army Group Center designated a special partisan warning channel on which ambushed or threatened units could send out emergency calls.

The fateful role played by partisan units after the collapse of Army Group Center in June/July 1944 will be long remembered. By blocking the routes of withdrawal along the Beresina and at other points they contributed effectively to the German disaster.

The German top-level command was greatly interested in the degree of co-operation between the Russian combat and partisan forces. Before any major operation or offensive the partisan units were given combat missions designed to disrupt the German lines of communications. By inter-

~~CONFIDENTIAL~~~~Security Information~~

~~CONFIDENTIAL~~
~~Security Information~~

MS# P-038
App. IV

-211-

cepting and evaluating these orders the Germans were able to deduce the directions in which the Russians intended to attack. The partisan units behind the German lines kept pace with the westward advance of the Russian forces and some of them did not join up with the latter until they had reached the immediate vicinity of the German frontier. The movements and the direction taken by these units, as indicated by intercepted radio messages, often furnished valuable clues to the Germans.

The Russian plans were even more clearly revealed by the radio traffic of their strategic intelligence sections. These were teams, eight to twelve men strong, operating ten to sixty miles behind the German lines. Their mission was to gather information for the Russian army and army group staffs concerning German lines of communications, supply depots, and garrisons occupying inhabited localities. The points of commitment, orders for and reports from the intelligence section commanded by Major Buchmostov, for example, were observed for many months in 1943-44 behind the German Third Army front in the Vitebsk area. Of strategic importance were the spy teams which the Russians dropped from planes far ahead of their major offensive thrusts. These spy teams consisted of one radio operator and three to five men; those operating on Polish territory were of Polish nationality; those dropped in German territory were former German prisoners of war. The radio messages containing their observations provided the German higher-echelon command with excellent clues as to the Russians' intentions.

These results must be credited to the previously-mentioned partisan

~~CONFIDENTIAL~~
~~Security Information~~

~~CONFIDENTIAL~~
~~Security Information~~

MS # P-038
App. IV

-212-

RCI units which were given specialized training for this technically complicated task and worked in close co-operation with the other RCI units.

b.b. Poland

The radio operators among the Polish partisans and in the Polish resistance movement were also outstanding. The resistance organization, with headquarters originally in Warsaw, where six of its radio stations were neutralized by German radio counterintelligence, was in contact with the central radio control station of the Polish government in exile in London. Within Poland the organization followed the lines of the former military district subdivisions. The itinerary of the Polish troops under General Anders after their expulsion from Kuibishev, Russia, through the Near East to Cairo, and from there to North Africa and southern Italy was observed and reported by radio counterintelligence.

The Polish partisans were as effective as their Russian counterparts in harassing German lines of communications. Their activities steadily increased up to the time of the uprising led by Polish General Bor in Warsaw during the autumn of 1944, as the Russians were approaching the city. Numerous radio messages were sent by the insurgents to the Polish First and Second Armies then fighting with the Russians in an attempt to induce them to intervene. The traffic with London at that time dealt with plans for supply by air.

During this rebellion Polish partisans who had advanced from woods south of Modlin attacked the evaluation center of the German Ninth Army located on an estate west of Warsaw. After heavy fighting, during which

~~CONFIDENTIAL~~
~~Security Information~~

~~CONFIDENTIAL~~
~~Security Information~~

MS # P-038
App. IV

-213-

five officers and many noncommissioned officers and enlisted men were killed, some panzer troops and liaison planes loaded with bombs answered the radio calls of the evaluation center and relieved its remaining personnel.

c.c. The Balkans

In this theater the partisans became such a threat to the occupying power that, after about the autumn of 1943, when the observation of British forces in the Near East and in eastern North Africa was no longer a source of much interest, practically all the available communication intelligence personnel were switched to anti-partisan operations. In keeping with the low educational level of the partisans, their radio techniques and codes were simple and easy to solve, indeed much easier than the Russian and Polish systems. On the other hand the Balkan partisans did maintain a high degree of radio discipline and refrained from transmitting in the clear. On the whole, their radio communication was good. A large variety of short-wave sets were in use, ranging from locally-produced equipment to that furnished by the British and Americans. Because of the threat of partisan attacks and the technical difficulties encountered in mountain terrain, the Germans were unable to use direction finders. Their employment was unnecessary because any data referring to localities could be obtained through message analysis.

The radio traffic of the resistance force under General Draja Mihailovic was observed from the beginning of 1942, first from Athens, later from Belgrade. Radio intelligence provided information on the

~~CONFIDENTIAL~~
~~Security Information~~

~~CONFIDENTIAL~~~~Security Information~~MS # P-038
App. IV

-214-

organizational structure, composition, strength, and concentration areas of this force; occasionally, also, its plans for future operations, but more often those which had recently been completed; combat actions, the course of the front lines, shifting of forces, temporary disbanding and subsequent reactivation of combat units; deserters; projected and completed British supply flights, quantities of airdropped supplies, landing fields and their beacon lights; activities of the British and American military missions; behavior of the Italians and Bulgarians; and finally Mihailovic's attitude toward his various enemies, such as the Germans, Nedic, Tito, the Croats, Ustashi, Montenegrins, Albanians, and others.

As early as mid-1943 Mihailovic recognized Tito's threat to Serbia, and from then on he also fought against Tito's units whenever they devastated Serbia in their raids launched from Croatia. He himself advanced only occasionally into Croatia while fighting against German troops. British and subsequently American military missions were first assigned only to Mihailovic's staff, later on also to those of his subordinate commanders. Radio intelligence established how these military missions organized the flow of supply to the resistance groups, first by air, and later also by sea from Allied-held southern Italy. In some months as much as 1,000 tons were dropped. The military missions probably also exercised some influence on the course of operations, as was evidenced by Mihailovic's precise instructions to his senior commanders concerning their conduct toward the military missions, and by complaints submitted by the latter. German RCI observed that, after similar military missions had been sent to Tito,

~~CONFIDENTIAL~~~~Security Information~~

~~CONFIDENTIAL~~~~Security Information~~MS # P-038
App. IV

-215-

those with Mihailovic were recalled, at first gradually and then more and more rapidly. Mihailovic was not so concerned about the Americans, but when their departure was followed by that of the British who had hitherto been his chief military and political supporters, he was dismayed and his subordinates were stunned. The continued support of the Yugoslav government in exile in London and of King Peter offered little consolation. After they had been abandoned by the British and Americans, some of Mihailovic's subordinate commanders were ready to come to some sort of armistice agreement with the Germans and to join up with them in the defense of Serbia against Tito. However, Mihailovic remained true to his principles. His radio message read: "Our enemy number one is the occupying power, Germany, and all our efforts should be directed against this enemy." He continued to profess his loyalty to England, the United States, and the democratic ideals of freedom, and until the end he exhorted his senior commanders to remain true to the cause and to carry on the struggle against the Germans.

In early 1943 the volume of Tito's radio traffic was still small, but it increased rapidly and soon exceeded that of Mihailovic, which declined together with his waning star. Since Tito's radio technique was as simple as that of Mihailovic, German radio intelligence was able to achieve equally complete coverage. Every detail about him and his activities became known to his enemies as well as the fact that he considered the Croatian government, the Ustashi, Mihailovic, Nedic, and others his bitter enemies. As in the case of Mihailovic, the struggle against the Germans

~~CONFIDENTIAL~~~~Security Information~~

~~CONFIDENTIAL~~~~Security Information~~MS # P-038
App. IV

-216-

had top priority with Tito. In politics, however, Tito recognized only two factions: he and everything he stood for was "democratic," while all those who were not on his side were "fascists," whether they were Germans or Serbian royalists. The arrival of the American military mission was soon followed by that of the British. Finally, when the Russians approached the Balkans, they also sent a mission to co-ordinate the delivery of supplies by air.

In addition to providing information on the confused political situation in the Balkans, German communication intelligence also furnished definite proof of the duplicity of Germany's allies and satellites, less on the part of the Bulgarians than on that of the Italians. It was characteristic, for example, that the Italians accepted an offer to exchange one of their generals, who had been captured by Mihailovic's troops, for a field gun and ammunition. Toward the end of 1943 the Bulgarians also began to engage in double dealing.

Finally, the Balkan partisans played a similar and perhaps even more important part against the weak German occupation forces than their counterparts in White Russia. Even though radio intelligence did provide reliable information for effective counteraction, the means to enforce any such measures were not available.

During the belated German evacuation of the Balkans at the end of 1944, the partisans inflicted heavy casualties on the Germans who were retreating under great hardships.

~~CONFIDENTIAL~~~~Security Information~~

~~CONFIDENTIAL~~~~Security Information~~MS # P-038
App. IV

-217-

6. Appraisal of Allied Subversive Radio Activities

The Russian subversive radio activities, consisting of agent-operated, partisan, and spy-team nets, held second rank among the Allied services of this type. The Russian personnel employed in these operations were well trained, transmitted rapidly, and always/a high degree of discipline. The German RCI units observed that at the beginning of these activities the Russians attached no particular value to concealment. However, soon afterward they introduced complicated traffic schedules, sometimes adapting them to German radio procedures. Approximately forty of the spy teams were apprehended. As a result of the arrests made in western Europe in 1944, the Germans were able to halt Russian radio-agent activity in the territory they occupied at that time, i.e., France, Belgium, and Holland. The Russian intelligence service in western Europe was limited to the three stations in Switzerland, which were out of German reach.

The British agent-operated radio service, with London and Cairo as its headquarters, had more than 50 percent of the total number of Allied radio agents at its disposal, was the most efficient of all. At first, as the result of too-hasty training, the British had very few good radio operators and thus their radio discipline was inadequate. However, they gradually improved their radio procedures, so that toward the end of the war it was just as complicated and difficult to intercept and evaluate as was that of the Russians. Attempts to imitate German operating procedures were occasionally observed. In 1943 the location of the British central control station at a point about forty miles northwest of London was

~~CONFIDENTIAL~~~~Security Information~~

~~CONFIDENTIAL~~~~Security Information~~MS # P-038
App. IV

-218-

determined by fast-flying German airplanes equipped with short-range D/F sets and definitely identified by photographs of its antennae. Interestingly enough, a request for an air attack against this installation was refused, because of the existing shortage of aircraft and the meager prospects of success. On the basis of the British radio traffic with the Maquis in central and southern France, the Germans were often able to anticipate air drops and get hold of the supplies themselves.

American radio agents were of minor significance. The radio operators used ultrashort-wave equipment and were in contact with airborne control stations. Their communications were easy to intercept. All twelve radio agents who operated in Northern France at the time of the Allied invasion were apprehended by the Germans.

The Polish agent-operated radio service had good operators but simple procedures based on those of the Polish Army. Its main advantage was that it was guarded by strongly armed lookouts. The Czech radio agent service, like the Polish, was easy to observe.

In summing up one may state that German RCI operations were hampered by excessive division of responsibility, duplication of effort, and jurisdictional confusion, all of which fitted into Hitler's pattern of "Divide and Rule." Needless to say that the military and political interests of the country should have been the primary consideration. No practical measures were taken to simplify and streamline the organization by putting active and passive RCI operations under a unified counterintelligence service. Moreover, a decisive solution to the problem and the greater

~~CONFIDENTIAL~~~~Security Information~~

~~CONFIDENTIAL~~~~Security Information~~MS # P-038
App. IV

-219-

effectiveness to be thus gained were obstructed by influential traitors. It is, therefore, to the credit of German military counterintelligence that, in spite of these sinister machinations and obstructionist tendencies, many successes were scored which constituted a tangible advantage for the German Army.

~~CONFIDENTIAL~~~~Security Information~~

~~CONFIDENTIAL~~
~~Security Information~~

MS # P-038

-220-

Appendix V

Cryptanalysis

Before the outbreak of the war the Cryptographic Branch of the Armed Forces Signal Communication Group at OKW had obtained a sufficient volume of encrypted material from the observation of international official and diplomatic radio traffic, and its personnel strength was adequate for the workload. On the other hand, the peacetime volume of intercepts from foreign armies was relatively small, except for occasional brisk traffic during maneuvers. In the Evaluation Control Center of OKH the personnel strength of the Cryptanalysis Section was so low that only five men were available for analyzing British traffic. The T/O of the fixed intercept stations provided for six cryptanalysts, while at that time (1939) the intercept companies had none. At the beginning of the war it was therefore far from easy to bring the cryptanalytical personnel strength of the Army up to minimum requirements.

In 1939, the mission of Army cryptanalysis was therefore limited to the following:

- a. Analyzing and solving all enemy army radio ciphers;
- b. Expediting the dispatch of solved messages of a tactical nature to the Army General Staff and those of a technical nature to radio intelligence;
- c. Guiding intercept operations to ease the task of cryptanalysis;
- d. Improving cryptanalytic procedures; and
- e. Training cryptanalysts.

~~CONFIDENTIAL~~
~~Security Information~~

~~CONFIDENTIAL~~~~Security Information~~MS # P-038
App. V

-221-

Even during the French campaign, German army cryptanalysis was so short of personnel and equipment that it was unable to take advantage of the sudden increase in the volume of messages. As a result, the tactical information it produced frequently failed to reach the user agencies in time.

The considerable expansion of Army cryptanalysis during the war led to the second plan of organization, which continued to exist from 1942 until the end of the war. Under the Cryptographic Branch of OKW was the Army Cryptanalysis Section in the Evaluation Control Center. This section controlled the interpreters' school, the fixed intercept stations (six cryptanalysts), the cryptanalysis section of army groups (fifteen men), and the Cryptanalysis Section East at OKH. The cryptanalysis section of an intercept company had eight men, while short-range intercept platoons had two cryptanalysts.

After sufficient personnel had undergone intensive training at the Evaluation Control Center, the communication intelligence units in the field could be provided with their own cryptanalysis sections. In selecting trainees one third of the total was taken from the ranks of qualified mathematicians, such as statisticians, actuaries, and college instructors; the other two thirds were linguists. Some specialized in the solution of manual ciphers; others, in that of mechanical ciphers. The training courses for cryptanalysts lasted six to eight weeks. The linguists were first trained in military terminology at the Army Signal Language School. Only individuals who mastered a foreign language so completely that they

~~CONFIDENTIAL~~~~Security Information~~

~~CONFIDENTIAL~~~~Security Information~~

KS # P-038
App. V

-222-

were able to think and feel in it could be used as cryptanalysts.

In 1942 the cryptanalysis functions were subdivided as follows:

1. Cryptanalysis Section at the Evaluation Control Center (Personnel Strength approximately 200)

- a. Analyzing and solving all new cryptosystems;
- b. Analyzing ciphers whose solution required a large number of personnel and the use of mechanical equipment; and
- c. Transmitting solutions to cryptosystems, according to their complexity, either to the cryptographic sections in the evaluation center of the communication intelligence commanders, to the intercept companies, or to the fixed intercept stations, so that these agencies would be in a position to solve by themselves any message encrypted in the same system.

2. Cryptanalysis Section in the Evaluation Center of the Communication Intelligence Commander (Personnel Strength approximately 15)

- a. Solving currently intercepted messages with the assistance of the solutions supplied by the Evaluation Control Center;
- b. Solving simple field codes;
- c. Co-operating with the evaluation sections in all matters pertaining to the volume and contents of messages;
- d. Co-operating with the cryptanalysis section of individual intercept companies and fixed intercept stations in their attempts to solve simple field codes and their daily changing encipherment, and to interpret signal charts, code designations, and their encipherment.

~~CONFIDENTIAL~~~~Security Information~~

~~CONFIDENTIAL~~~~Security Information~~

MS # P-038
App. V

-223-

3. Cryptanalysis Section of Intercept Companies and Fixed Stations (Personnel Strength approximately 8).
- a. Solving the day-to-day encipherments to the system previously solved by the Evaluation Control Center;
 - b. Solving very simple field codes;
 - c. Co-operating with the evaluation sections in matters pertaining to intercepting and evaluating messages; and
 - d. Interpreting call signs and code designations, and solving their encipherment.

4. Two Cryptanalysts Assigned to Short-Range Radio Intelligence Platoons.

- a. Assisting in intercepting enemy combat message traffic; and
- b. Solving and evaluating call signs and code designations.

No cryptanalysis proper was done at platoon level, because the necessary equipment was not supposed to be used in such proximity to the fighting.

This organizational structure was designed to centralize the performance of all complicated cryptanalytic jobs with the assistance of the numerous personnel available at the Evaluation Control Center, leaving the simpler tasks to the decentralized field agencies. In this manner the contents of analyzed messages could be forwarded to higher headquarters in good time, thus dispensing with the former time-consuming detour via Berlin.

~~CONFIDENTIAL~~~~Security Information~~

~~CONFIDENTIAL~~
~~Security Information~~

MS # P-038
App. V

-224-

Organization and Operating Procedure of the Cryptanalysis

Section at the Evaluation Control Center

A number of subsections and units were responsible for solving newly-encountered cryptosystems, manual and mechanical ciphers, and for developing new cryptanalytic methods. Each foreign language unit solved messages encrypted in manual and mechanical ciphers with the assistance of a varying number of linguists. The cryptanalytic procedure unit collected the mathematical and linguistic data acquired by all the other units and subsections, which in turn consulted this reference material to get hints for solving the problems on hand. It was best to have a choice of several lines of attack, because with only one available the analyst ran the risk of reaching a dead end.

Because of the great distance between North Africa and Germany, a cryptanalysis section was included in the intercept company assigned to the Africa Corps, even before the general introduction of this organizational measure. This section was to solve field ciphers on the spot and forward the results to higher headquarters without delay.

In 1941 the entire Russian language unit was transferred to the Evaluation Control Center East under the Chief of Army Signal Communication located at Hitler's headquarters in East Prussia. The peculiar manner in which the Russians handled their cryptosystems — the same code book and authenticators were used along the entire front — made it necessary to centralize all daily intercepts in order to have sufficient material for solving the day-by-day encipherment of the higher-echelon traffic.

~~CONFIDENTIAL~~
~~Security Information~~

~~CONFIDENTIAL~~~~Security Information~~

MS # P-038

-225-

App. V

The long distance between the Russian front and Berlin precluded the possibility of solving ciphers in time so that the contents of messages could be of tactical value. On the other hand, the Fuehrer headquarters in East Prussia had excellent wire communication with the army group headquarters. Nevertheless, contact with the mathematics and the punch-card machine units in Berlin was maintained, because their activities were essential to the functioning of all other units.

The prerequisite for solving a difficult cipher was to secure as much text as possible encrypted in the same system and the same day-by-day encipherment. This material was used to find messages of the same length, the same beginning or ending, or with the same sequence of letters in the text -- the so-called cribs. These constituted the first points of attack from which the entire system could be broken. The manual sorting of messages required too large a staff, and quicker and more accurate results could be obtained by employing punch-card machines, despite the fact that every message had to be transferred to a punch card.

The records unit had reference material such as military dictionaries, glossaries of trade terms, dialects, slang, and abbreviations, as well as personnel records.

The encrypted teletype traffic unit was engaged in research on and the solution of teletype and radio teletype encipherment systems. The other mechanical systems are mentioned in Appendix VII. Some of them were analyzed by the Cryptographic Branch of OKW.

~~CONFIDENTIAL~~~~Security Information~~

~~CONFIDENTIAL~~~~Security Information~~

MS # P-038

-226-

App. V

Following its organization in 1942, the unit assigned the solution of enemy agent ciphers produced good results in conjunction with radio counterintelligence. In contrast to common cryptographic usage, radio agents employed a different encipherment for each message, so that the cryptanalyst had to wait for encryption mistakes or other clues that might be provided by the radio operators before he could proceed with his analysis. After Army cryptanalysis had laid the foundation for this activity and had derived benefit from its existence by obtaining the solution to some new systems, the unit was transferred to the Cryptographic Branch of OKW in late 1943.

The mission of the Cryptographic Branch of OKW was to improve the German cryptosystems, devise cryptographic operating procedures and equipment, and keep a constant check on the security of the cryptomaterial used by the three services. Security violations which offered breaks for enemy cryptanalysis, such as encryption errors, had to be eliminated. In addition to that, maximum security of the German cryptographic devices had to be ensured. In this connection it was presumed that the enemy had in his possession samples of German cryptographic devices, such as cipher machines and grilles, as well as operating instructions and was only ignorant of the encipherments which were changed every day. It was therefore necessary to determine how many letters per day could be encrypted with the same encipherment without offering the enemy some opportunity for compromising its security. In other words, the extent to which individual systems could be used had to be established in each instance. For this

~~CONFIDENTIAL~~~~Security Information~~

~~CONFIDENTIAL~~
~~Security Information~~

MS # P-038
App. V

-227-

purpose the unit designated to safeguard the security of German cryptosystems subjected messages sent by German stations to routine cryptanalysis in order to find out whether German security was adequate or in need of further tightening and also whether the field forces made any mistakes which might compromise security. A situation in which the enemy would be able to compromise German messages, because the cryptographic security had been overestimated, had to be avoided at any cost. If more stringent security measures were needed, the use of individual ciphers would have to be restricted in order to provide the enemy with less subject matter.

To replace an unsatisfactory system by a better one was an extremely complicated task. Even when a substitute system was readily available, the process of assembling and distributing the new cryptographic material required considerable time. Even more time-consuming was the training of personnel in the use of the new system. If the training was not sufficiently thorough, the mistakes made in the beginning of its application might compromise the security of the new system from the very start. Since any system is subject to compromise at some time, changes had to be scheduled at certain intervals.

If there were indications that the enemy was about to change his system, traffic observation had to be intensified in order to uncover immediately any mistake made during the transition, such as the simultaneous use of two ciphers for the same traffic, the repetition of previously transmitted messages in the new cipher, and other common errors due to inexperience which might compromise the new system from the outset.

~~CONFIDENTIAL~~
~~Security Information~~

~~CONFIDENTIAL~~
~~Security Information~~

MS # P-038
App. V

-228-

The cryptanalysis section of the Evaluation Control Center succeeded in solving about 50 percent of all the messages which had resisted lower-echelon cryptanalysis.

In summarizing, one may state that the security of enemy and German ciphers depended on their mathematical structure, on the number of possible modifications, on the frequency of change, and, in the final analysis, on the methods used for their production and distribution. The smaller the area in which a cipher was used, the less material there was that became available to enemy cryptanalysis, and the less serious was the compromise of the cipher.

The German Army established the following three categories for its cryptosystems: for higher-echelon traffic absolute security within the limits of feasibility; for intermediate-echelon traffic, temporary security for about three days; and, for combat messages, several hours of effective concealment. The effectiveness and security of enemy systems were classified according to the same standards.

The field forces asked for systems which could be operated rapidly without increasing the weight and complexity of the radio equipment, and the loss of which would not threaten serious consequences. These desiderata ran contrary to the security requirements. Secure systems caused delays and were too complicated for use by tank crews and the like. Moreover, cipher machines were heavy and bulky. To meet the demands of the field forces was all the more difficult, because one never knew whether the enemy possibly employed better methods which permitted him to operate

~~CONFIDENTIAL~~
~~Security Information~~

~~CONFIDENTIAL~~~~Security Information~~MS # P-038
App. V

-229-

at even greater speeds. Unfortunately there was no possibility of measuring the caliber of one's own encryption against the enemy's skill at cryptanalysis, since these matters are among the most closely guarded secrets of any nation.

In any event, a belligerent who overestimates the security of his cryptosystems, underestimates enemy cryptanalysis, and does not strive constantly to perfect his own systems, while setting up the highest possible standards, commits a grave mistake.

German cryptanalysis was always directed by highly-competent signal officers with experience in radio communication and intelligence, and in tactical and technical problems involving signal functions. To place this organization in the hands of cryptanalytic experts would not have been practical, because, however qualified they were in their own spheres, they lacked the necessary perspective and understanding of the techniques of the enemy's radio communication.

Because of the special characteristics of Soviet cryptosystems and their importance to German communication intelligence in Russia, a brief explanation of these systems is in order at this point.

The Russian Army did not use mechanical ciphers but employed code systems uniformly throughout the entire theater of operations. From the regimental level on up, cryptography was the responsibility of specially trained cryptographic officers, who used secure systems which were subject to frequent change. Since virtually every Russian headquarters required

~~CONFIDENTIAL~~~~Security Information~~

~~CONFIDENTIAL~~~~Security Information~~MS # P-038
App. V

-230-

that a different code be used in each direction when communicating with subordinate units, the Germans often found it very difficult to obtain sufficient material for solving Russian higher-echelon radio messages. The solution of tactical messages was easier, since the systems themselves were simpler and the operators were often too indolent to use substitute designations for frequently recurring terms, as had been directed.

At the front the Russians often transmitted numerical-code messages by voice and CW. In the latter case the average speed of transmission was so slow that the German intercept operators, regardless of their degree of training, could easily copy them. Such messages were often solved by personnel of the short-range intelligence companies without assistance, and the contents quickly made available to the combat units concerned.

The Russian code books differed technically from the German ones. The Russians used exclusively substitution systems in which letters, syllables, words, sentences, and numbers were expressed by numerical code groups, as described below:

Two-digit cryptograms (groups consisting of two figures:

Consisting of only 100 pairs (concepts), these cryptograms were intended only for technical operation which could be solved in almost all cases.

Three-digit cryptograms (groups consisting of three figures):

This was the most frequently used field code.

Solution was possible in 80 percent of all cases.

These cryptograms became more and more complicated

~~CONFIDENTIAL~~~~Security Information~~

~~CONFIDENTIAL~~
~~Security Information~~

MS # P-038
App. V

-231-

during the war, and a body of experienced analysts was needed to solve it. Each radio net had its own code, so that captured codes were never of any use. The time required to break a code varied between several hours and several weeks. However, once the basic code and the substitution table had been determined, all intercepted messages were solved within a few minutes. This code offered 1,000 different combinations.

Four-digit cryptograms (groups consisting of four figures);

This was ^a/rarely used field code which offered 10,000 combinations and required a fairly large volume of text for its solution.

Five-digit cryptograms (groups consisting of five figures):

This was the most frequently used code for higher-echelon messages. It consisted of 100,000 combinations. In general only the Cryptanalysis Section at the Fuehrer headquarters was qualified to attempt solutions. Even these messages were solved in 50 percent of all cases.

The Russians tightened their security measures during the war, but without making any basic changes in their systems. On the whole, German cryptanalytical procedures were able to keep up with them.

~~CONFIDENTIAL~~
~~Security Information~~

~~CONFIDENTIAL~~~~Security Information~~MS # P-038
App. V

-232-

The significance of one single error in the use or distribution of a code is illustrated by the following example: From the northernmost area of the Russian front, Army RI observed the Soviet Northern Fleet in the Arctic, including its air raid warning stations and fighter units. In the spring of 1943 one of these air raid warning stations notified a fighter airfield on the Kola Peninsula that a convoy was approaching from Iceland and would reach a certain point at a certain time. This message was encoded in the simple three-digit code and was solved at once. Immediately notified, the Luftwaffe and Navy destroyed most of the ships in the convoy. Had the message been sent in the five-digit code, which was generally used for such important dispatches, its solution plus the time needed for transmitting it would probably have taken several days, and the encryption would have fulfilled its purpose.

The German communication intelligence experts had expected that, in the event of war, message evaluation would be of only slight importance, since the enemy would protect his communications with impregnable codes. It was for this reason that so much effort had been devoted to the development of traffic analysis. However, thanks to the work of German cryptanalysts and the errors committed by the enemy, these expectations failed to materialize, except in the case of those higher-echelon codes, which could not be broken. Thus, even though the emphasis shifted to traffic analysis in World War II, cryptanalysis continued to furnish a major part of the over-all results produced by radio intelligence.

~~CONFIDENTIAL~~~~Security Information~~

~~CONFIDENTIAL~~
~~Security Information~~

MS # P-038

-233-

Appendix VI

Appraisal of Short-Range Communication Intelligence

What was the opinion of the effectiveness of communication intelligence held by the user agencies in the field and within the Army General Staff? There is no need to emphasize that before the outbreak of hostilities the intelligence officers of these agencies were provided with information on Germany's potential enemies, and that some of this information was derived from peacetime observations of the intercept agencies.

At the beginning of the war the chance successes achieved by the short-range intelligence platoons forming part of the division signal battalion were of definitely secondary importance. By 1943, however, this situation had changed radically. In Russia the division intelligence officer received interesting daily reports about the enemy from the auxiliary evaluation section of the short-range intelligence company attached to corps headquarters. In Italy and western Europe important information obtained by communication intelligence was also disseminated over the broadcasting system. Moreover, the short-range intelligence teams, which were improvised by most front-line divisions, facilitated the conduct of operations in some sectors to such an unexpected degree that they were found indispensable.

During position warfare the results obtained by short-range intelligence teams were minor because the enemy used telephone lines, dispatched messengers, and observed strict radio discipline. Such quiet periods had to be utilized for studying enemy radio techniques, for training the personnel of the small units, and for co-ordinating procedures in dealing with division

~~CONFIDENTIAL~~
~~Security Information~~

~~CONFIDENTIAL~~~~Security Information~~MS # P-038
App. VI

-234-

headquarters. Once mobile warfare was resumed, enemy radio traffic reappeared with messages either partly or wholly in the clear, giving a wealth of information which could be immediately exploited in the course of the action. Under the pressure of combat, untrained or undisciplined radio operators and tactical commanders were often oblivious to security regulations, all the more so when German countermeasures increased the already existing confusion.

The author of this appendix has in mind two situations, one during a delaying action, the other during position defense, when the division he commanded was excellently supported by the short-range intelligence team, much to the detriment of the careless opponent. The first episode occurred in March 1943 during the withdrawal of the Ninth Army from the Rzhev - Olenino area to new positions along the Vyazma - Yartsevo line; the second one, in 1944 during the heavy fighting against the British in the Normandy beachhead. Both actions have been described in the chapters of the main part of this study dealing with these two theaters.

In both instances the division intelligence officer, who always stayed in the immediate vicinity of the operations officer and the division commander, installed the short-range intelligence team consisting of several radio operators and linguists in his own house, tent, or truck. Important intercepts were immediately reported to the operations officer and the division commander. During heavy fighting the intelligence officer conveyed the latest information to the division commander while the latter was looking through his tripod-mounted telescope. The division commander was thus in a

~~CONFIDENTIAL~~~~Security Information~~

~~CONFIDENTIAL~~~~Security Information~~MS # P-038
App. VI

-235-

position to supplement his own personal observations of the enemy and those of his ground reconnaissance units with intercepted messages indicating the enemy's plans, requests for artillery support and situation reports. On the basis of this authentic information he was well placed to order appropriate countermeasures within the limits of his resources and reserves, be they artillery concentrations, ground reconnaissance, counterthrusts, or troop concentrations. He could also warn or withdraw troops located at special danger points. There were many instances in which short-range RI operated successfully during the last years of the war against the Russians, British, and Americans. By 1944-45 the results obtained by communication intelligence probably amounted to as much as 75 percent of all the tactical information available to division commanders.

Although, without communication intelligence units of their own, the corps probably obtained about the same percentage of information from that source. The corps intelligence officer had to rely on whatever information was passed on to him from higher and lower echelons. Whereas on the division level only enemy voice communications were intercepted in the above manner, the corps intelligence officer also received much information from CW messages, which were encrypted in such very simple codes and field ciphers that they could be solved by evaluation sections of the short-range intelligence company stationed in the corps sector.

Another criterion for judging the effectiveness of communication intelligence was whether its results arrived in time. At division level no special channels had to be established for this purpose. In view of the

~~CONFIDENTIAL~~~~Security Information~~

~~CONFIDENTIAL~~~~Security Information~~MS # P-038
App. VI

-236-

generally limited width of the corps sector, the corps signal battalion was usually able to set up the necessary wire facilities. But the extensive area covered by army and army group sectors, and the correspondingly wide area over which the communication intelligence units had to be spread, necessitated the employment of a highly efficient signal communication service to ensure the speed and accuracy of operations. For this reason certain telephone and teletype lines at army and army group level were reserved for communication intelligence. In addition, direct long-distance lines leading from OKH headquarters to the various theaters of operations were reserved for Evaluation Control Center traffic.

At least once a day the higher-echelon commands needed a complete summary of the messages intercepted on the preceding day. For tactical purposes (at the intermediate level) the evaluation results had to be produced within a few hours at the most, whereas those which were to be useful in combat areas could not be delayed more than a few minutes, if not seconds. Operations, procedures, and communication with the various headquarters on different levels had to be organized accordingly. After the causes for its initial failures in 1939 and 1940 had been eliminated, German communication intelligence was able to comply with these requirements during the later years of the war.

By 1943 the intelligence officer at army level, who had never been without some communication intelligence support, was assisted by an efficient communication intelligence battalion. Whereas the commander of communication intelligence at army group level was in charge of the battalion

~~CONFIDENTIAL~~
~~Security Information~~

~~CONFIDENTIAL~~~~Security Information~~MS # P-038
App. VI

-237-

with respect to technical and administrative matters, it was the intelligence officer at army level who assigned the battalion its specific missions. The evaluation section of the short-range intercept company provided him with tactical data from intercepted traffic from the area in the path of the army, while the long-range intercept company reported on the higher-echelon traffic. Since many simple keys could be solved at this level, the radio situation reports contained comprehensive information derived from traffic analysis and message evaluation.

At army group level the material derived from these sources was even more comprehensive. The information available at army level was supplemented by the evaluation of analyzed messages which, because of their importance, had been transmitted in complicated ciphers. The commander of communication intelligence was administratively subordinate to the army group signal officer but was given his missions by the intelligence officer. A liaison/permanently assigned to duty with the intelligence officer made a verbal report at least once a day on the RI picture and submitted without delay any information of special interest. Moreover, the commander of communication intelligence reported in person on matters of particularly great significance.

At army group level, just as at army level, the productivity of communication intelligence had amounted to approximately 75 percent of the total intelligence available as of 1943. This figure remained fairly stable until the last weeks of the war, when communication intelligence (both radio and wire) provided 95 percent of the total. This fact was confirmed on

~~CONFIDENTIAL~~~~Security Information~~

~~CONFIDENTIAL~~~~Security Information~~MS # P-038
App. VI

-238-

several occasions, by Field Marshal Kesselring when serving as OB West.

The Evaluation Control Center compiled the information obtained by the army groups and added material of its own obtained from traffic analysis and the solution of the more complicated cryptosystems. Liaison officers who were on permanent duty with the Eastern and Western Intelligence Branches (the intelligence units in the offices of the Chiefs of the Army General Staff and Armed Forces Operations Staff) submitted communication intelligence information to these user agencies.

As a matter of principle, communication intelligence never based its operations on information from other sources, such as prisoner of war interrogations, reports from agents, and air reconnaissance, but at the most used them only to confirm its own results. In the course of World War II the intelligence experts in the Army General Staff formed the opinion that in most instances communication intelligence results could be accepted without confirmation. By the same token reports from other sources were not regarded as reliable until confirmed by communication intelligence. During the first years of the war some of the doubts as to the reliability of communication intelligence had dire consequences for the Germans, but this situation was subsequently corrected. Actually communication intelligence was superior to air and ground reconnaissance, because the latter could furnish reliable information on only those objectives which the enemy had not concealed from view. It was also superior to subjective statements of prisoners and agents, whose information was often made to fit the purpose and could not be immediately checked, quite apart from the fact that it was

~~CONFIDENTIAL~~~~Security Information~~

~~CONFIDENTIAL~~
~~Security Information~~

MS # P-038
App. VI

-239-

often received too late.

Communication intelligence could observe even camouflaged night movements. Moreover, on the basis of the most dependable data, namely the enemy's own careless statements, it could learn of the enemy's intentions in time to take preventive countermeasures. No intelligence expert on the German General Staff could afford to neglect the information obtained by communication intelligence. The majority of the tactical commanders, from division commander up to the Chief of the Army General Staff, attached utmost importance to this type of intelligence in formulating their decisions. Only Adolf Hitler, the Supreme Commander of the Wehrmacht and Army, withheld his recognition in spite of the tragic blunders he had committed before Moscow, at Stalingrad, and in North Africa, where in each instance he underestimated the enemy's strength in the face of warnings from communication intelligence. He continued to doubt the reliability of this type of intelligence at a time when it brought him more and more unfavorable, yet undeniable, information about the crushing superiority and strategic objectives of his enemies in the West after the Normandy invasion and in the East long before the Baranov offensive was launched in January 1945. By 1944-45 his antagonistic attitude toward communication intelligence reached the point where he forbade the Chief of the Army General Staff and the Chief of the Eastern Intelligence Branch to report the "one-sided and distorted" information based on communication intelligence. On another occasion the Chief of the Eastern Intelligence Branch produced an overwhelming array of indisputable facts drawn chiefly from communication

~~CONFIDENTIAL~~
~~Security Information~~

~~CONFIDENTIAL~~~~Security Information~~

MS # P-038

-240-

App. VI

intelligence sources, including accurate data on the enemy's strength, order of battle, and probable moves, as well as his steadily increasing production of tanks and guns. Hitler's reaction to this factual account was the following: "I refuse to acknowledge the appropriateness of this General Staff activity. Only men of genius can recognize the enemy's intentions and draw the proper military conclusions, and such men would never stoop to perform this kind of petty routine."

Military history will pass a different judgment on this "petty routine," which was based on an infinite amount of German conscientiousness, organizational ability, and never-relenting devotion.

The allocation of responsibility for communication intelligence operations in 1945 is outlined in Chart 1.

~~CONFIDENTIAL~~~~Security Information~~

~~CONFIDENTIAL~~
Security Information

-240-A

MS # P-038

Chart 1
Appendix VI

Allocation of Responsibility for Communication Intelligence

Operations

Enemy Signal Communication Sources

German Communication Intelligence Agencies

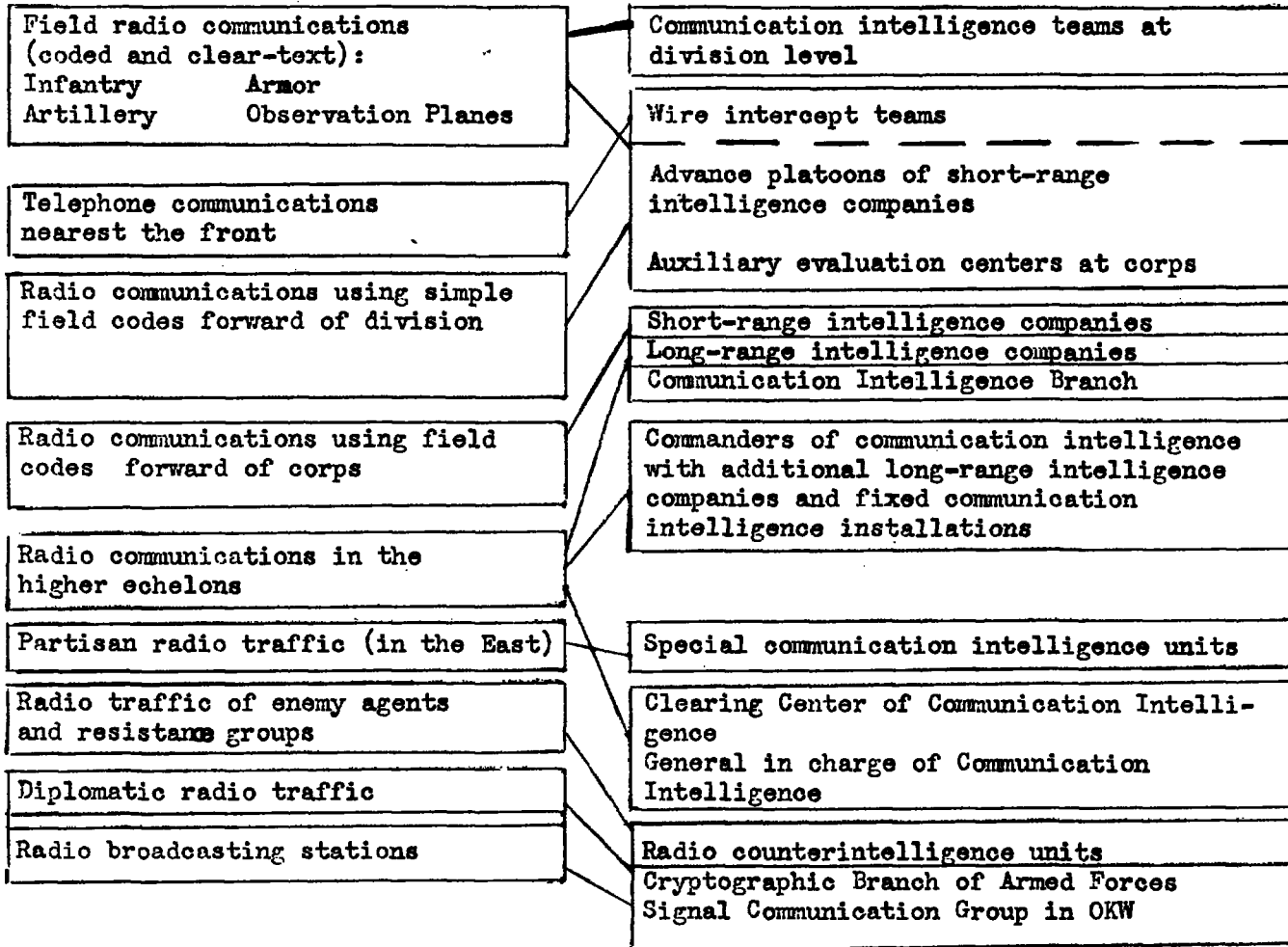

Note:

No mention is made here of the distribution of technical assignments according to frequencies and favorable reception areas for short waves, etc., or of the overlapping of receiving areas as the result of observation by several stations.

~~CONFIDENTIAL~~
Security Information

~~CONFIDENTIAL~~
Security Information

MS # P-038

-241-

Appendix VII

German Intercept Equipment

(This appendix is based on a report by Colonel L. Karn, who for many years held high positions in the Army Ordnance Office.)

1. Receivers

German receivers developed after 1937 covered the following wavelengths:

Model z:	30,000 to 4,000 meters
" a:	4,000 to 250 meters
" b:	250 to 80 meters
" c:	80 to 12 meters
" d:	12 to 5 meters
" e:	5 to 2 meters
" f:	2 to 1 meter

With the exception of category f, all models were available to the field forces after 1939. There was a 10 percent overlap between the respective frequency ranges. Maximum standardization of individual parts and assemblies for all models of receivers and direction finders was the aim of those in charge of production. The tuning elements of receivers and direction finders were installed and operated according to the same principles, in order to make possible the highest degree of co-ordination between intercept and D/F operators. Crystal filters guaranteed maximum selectivity. Ingeniously designed tank circuits eliminated interference from nearby transmitters.

In 1938 two additional light-weight receivers were developed for short-range interception covering the following wavelengths:

Model u:	400 to 12 meters, and
" v:	12 to 2 meters.

They were issued to the field forces in 1943.

~~CONFIDENTIAL~~
Security Information

~~CONFIDENTIAL~~~~Security Information~~MS # P-038
App. VII

-242-

As previously mentioned, models c, d, and e were captured by the British at El Alamein in 1942. A few weeks later a British technical journal paid professional tribute to several features incorporated into their design, and mentioned the lack of such constructive thinking in the development of English and American sets.

In the expectation of a long war, the Chief of the Army Ordnance Office issued the following instructions at the beginning of hostilities:

- a. The development of any equipment which might be ready for issue to the field forces during the following four years was to be continued;
- b. Any model of equipment developed by the Army was to be standardized with similar types introduced by the Navy and Luftwaffe, and interservice rivalry in such matters was to be abandoned;
- c. German technical developments were to be checked against the enemy's by comparing German with captured equipment; and
- d. All designs were to be simplified in order to facilitate mass production.

In compliance with these instructions, the minimum standards for receiver manufacture were lowered, and in the production of many individual parts substitute materials were used instead of critical ones. Subsequently, three receiver models -- a, b, and c -- were combined in a standard model y, which had a range of 4,000 to 10 meters. This new model embodied a 50 percent reduction in weight and a considerable increase in selectivity

~~CONFIDENTIAL~~~~Security Information~~

~~CONFIDENTIAL~~~~Security Information~~

MS # P-038
App. VII

-213-

and sensitivity. However, this model never got into mass production before the end of the war. Models e and f were combined in a second standard receiver with a range of five to one meter, which was issued to the three services in 1942. The new model was lighter and more effective than the older ones.

In keeping with the trend toward the use of shorter wavelengths, the following models were developed:

Model g:	100 to 80 centimeters
" h:	70 to 50 centimeters
" v:	30 to 15 centimeters

Although these models did reach the experimental stage, they were developed too late for mass production.

2. Antenna Amplifiers

As many as forty receivers operated around the clock in some of the fixed intercept stations and mobile intercept companies. In theory, optimum performance of a receiver was contingent upon the tuning of its antenna to the frequency which was to be guarded. At the fixed stations the Army Ordnance Office installed antennas in a pattern that permitted up to forty different tuning adjustments in the long, medium, and short-wave bands.

The mobile intercept companies operating twenty receivers would have required a veritable forest of antennas. This was impractical because of the time and materials required to set up twenty collapsible masts, the problem of camouflage, and the likelihood of mutual interference. The Germans therefore developed three multicouplers, by means of which up to forty receivers could be connected to the antenna system. The incoming

~~CONFIDENTIAL~~~~Security Information~~

~~CONFIDENTIAL~~~~Security Information~~MS # P-038
App. VII

-24-

radio frequencies were amplified and filtered by special amplifiers whose output was matched to the input requirements of the various receivers. Thus, for instance, antenna amplifier A corresponded to receiver models a to c (4,000 to 12 meters), amplifier B to models d and e (12 to 13 meters), and amplifier C, to model f (below 3 meters).

In 1943 ground-force intercept units were issued amplifier A and the Luftwaffe units, type B, while the production of the third type had to be postponed because of the shortage of broad-band tubes.

Several promising developments which had passed the experimental stage could not be introduced because of production bottlenecks. Among these was the directional antenna whose electrical length was adjustable and which limited reception to the direction of the enemy, thus aiding in the reduction of interference. Another abandoned project was the anchored helicopter which was to hold aloft high-altitude antennae designed to increase the range of reception by neutralizing the effects of the curvature of the earth.

The latter equipment was intended primarily for intercepting ultra-short-wave traffic below ten meters, particularly that of enemy armored units. At an altitude of 1,650 feet the effective radius of operations was 95 miles, while at an altitude of 6,600 feet the range increased to 155 miles. The helicopter itself contained only the antenna, the radio frequency circuits of the receiver, a power generator, and a remote-control mechanism. The latter was controlled through the anchor cable by means of carrier frequencies. Whereas the first experimental high-frequency

~~CONFIDENTIAL~~~~Security Information~~

~~CONFIDENTIAL~~
~~Security Information~~

MS # P-038

-245-

App. VII

sets were produced as early as 1942, the helicopters did not become available for issue during the war. Thus, although technically feasible, the interception of ultrashort-wave traffic from great distances could not be carried on because of the lack of helicopters. The fact that the radio traffic of enemy armored units in Russia and western Europe could not be given adequate coverage constituted a serious gap in German communication intelligence.

3. Wave Indicators

In order to improve and simplify D/F operations, the Germans developed a wave indicator which projected visibly all detectable radio signals within a certain band of frequencies. By this means the operator could and measure the field strength/wavelength of the incoming signals and then select the signal he wished to copy on the receiver. The first experimental models were available as early as 1939, and the general issue to the field forces was supposed to have begun by 1943. Because of production difficulties this program was not realized; the only wave indicators actually issued were those destined for model a and b receivers. The other wave indicators which became available in 1943 were turned over to the Navy for its submarines, since these devices reacted to radar impulses. The wave indicator, with its superior precision, would have improved the effectiveness of operations by increasing the volume and quality of radio intercepts and through the saving of time and effort.

~~CONFIDENTIAL~~
~~Security Information~~

~~CONFIDENTIAL~~~~Security Information~~MS # P-038
App. VII

-246-

4. Recording Devices

When radio communication followed the example of wire communication in adopting mechanical transmission and recording procedures, the high-speed traffic of foreign fixed radio stations was at first recorded by means of wax matrix and steel wire recorders. In 1939 a further refinement was introduced in the form of the "Magnetofon," which employed an iron-oxide-coated cellophane tape. This device was used as a sound recorder by intercept units before and during the war. Short-range RI platoons were issued portable sound recorders after 1942.

For intercepting enemy messages sent over radioteletype and multiplex circuits the Germans established in 1944 a special recording center which consisted of eleven special radiotelegraph intercept devices which were tied in with sixty teletypewriters. This installation was a synthesis of recent technical developments in the field of radio and of experience with high-speed telegraphy. The average daily performance varied between ten and fifteen million characters, which could be raised to fifty million by around-the-clock operation.

This special recording center furnished cryptanalysis with a large volume of reliable texts and provided complete coverage of the widely-differing types of foreign high-speed CW and multiplex traffic. These messages were solved without actually possessing enemy transmitting and receiving sets and in spite of the fact that the Russians, Americans, British, and French had highly-developed teletype systems.

~~CONFIDENTIAL~~~~Security Information~~

~~CONFIDENTIAL~~~~Security Information~~

MS # P-038
App. VII

-247-

Facsimile transmission by radio was in extensive use by such Russian agencies as the NKVD and the Commissariat for Transportation. A net of about forty to fifty facsimile stations, several of which were in Siberia -- for instance, in Irkutsk, Tashkent, and Vladivostok -- transmitted hand-written communications, typewritten texts, drawings, and weather maps. However, none of the Russian facsimile devices ever fell into the hands of the Germans. Nevertheless, the latter did succeed in intercepting Russian facsimile messages with corresponding equipment.

Up to 1941 the Russians transmitted messages via facsimile in clear text. Even after the Russians had begun to use cipher machines, the Germans still had no difficulty in finding solutions and recording almost the entire facsimile output until the end of the war.

5. Direction Finders

The process of locating enemy radio stations was subject to the physical laws governing the propagation of electromagnetic waves. Researchers had to study the propagation and reflection of radio waves and related subjects in order to develop the most effective D/F techniques. The next steps were to construct easily-operated D/F equipment for employment in the field and to provide the RI units with accurate evaluation data which would be of use to an evaluator with the educational background of a sergeant. The D/F ranges were established as follows:

- a. Within one and a quarter miles of the objective -- RCI operations;
- b. Within twenty miles of the front -- short-range D/F operations;

~~CONFIDENTIAL~~~~Security Information~~

~~CONFIDENTIAL~~~~Security Information~~

MS # P-038
App. VII

-248-

- c. From 20 to 450 miles behind the front -- long-range D/F operations; and
- d. More than 450 miles behind the front -- very-long-range D/F operations.

In addition to the previously-mentioned naval direction finders, the Germans used a combination long and medium wave D/F set covering 4,000 to 80 meters and equipped with a rotating loop antenna. Its receiver was about 600 times more sensitive than an ordinary commercial set.

In order to improve the direction finder proper, the Germans introduced a goniometer using a fixed double-loop antenna, whose surface area could be made as large as 100 square yards. One loop was oriented north and south and the other was at right angles to it. They were mounted on a thirty-foot collapsible mast. At fixed intercept stations the entire D/F equipment was kept in permanent barracks, whereas the mobile intercept companies kept it in a tent or on a specially-built trailer. In the latter case the personnel was ready for operation within seven minutes after arrival at a new location. All intercept units were equipped with this type of direction finder as of 1939. The equipment was first tested by the German RI unit which participated in the Spanish Civil War.

For the purpose of intercepting the sky wave component of short-wave signals, fixed D/F equipment of the Adcock type was installed at the following stations: Koenigsberg/Kranz - Frankfurt an der Oder - Breslau-Striegau - Vienna/Tulln - Graz - Munich/Starnberg - Stuttgart/Wiesbaden-Euskirchen - Husum - Hillersleben/ Army Ordnance Office. This net was

~~CONFIDENTIAL~~~~Security Information~~

~~CONFIDENTIAL~~
~~Security Information~~

MS # P-038
App. VII

-249-

centrally controlled by direct wire lines. By using the main short-wave base lines Koenigsberg - Graz, Graz - Husum, Graz - Euskirchen, and Euskirchen - Koenigsberg the Germans were able to cover an area delimited by a line through central Scandinavia - Leningrad - Moscow - Kharkov - Odessa - Black Sea - North Africa - southern Spain - western Ireland - central Scandinavia. Additional mobile short-wave, long-range D/F equipment was installed on trailers and issued to the intercept companies during the course of the war.

In 1942 short-range D/F sets covering 400 to 12 meters were issued to the short-range intelligence platoons, whose mission it was to intercept the ground-wave component of short-wave signals. For the purpose of determining the exact location of agent-operated stations, RCI units were equipped with miniature direction finders which were carried on a belt under the operator's clothing. For these sets the earphones were replaced by an indicator about the size of a wrist watch.

For distances of less than sixty miles regular General Staff maps were adequate for D/F evaluation, while for greater distances the curvature of the earth had to be taken into consideration. For this purpose the Army Ordnance Office issued a 1:1,000,000 radio navigation map before the war which included the scale factor. As the need arose, the Army Ordnance Office disseminated additional radio navigation maps (1:2,000,000) which were produced by a photographic process and covered the entire area from the northern Arctic Ocean to Lake Chad, and from Iceland and Ireland to the Persian Gulf, the Caspian Sea, and the Ural mountains. They were

~~CONFIDENTIAL~~
~~Security Information~~

~~CONFIDENTIAL~~
~~Security Information~~

LS # P-038
App. VII

-250-

supplemented by four maps covering North America, South America, Asia, and Africa. Map distortions were eliminated by means of a D/F correction scale.

Within the scope of this brief survey directed at laymen the author has mentioned only the principal pieces of equipment which German radio intelligence introduced in order to keep pace with the progress in German and enemy radio techniques. Much auxiliary equipment served for training intercept operators and for improving and simplifying the performance of their duties. Numerous experiments designed to bring about additional improvements could not be concluded successfully before the end of the war.

The propagation of ultrashort waves and microwaves was studied during flights of the dirigible "Graf Zeppelin" in 1938-39.

An experimental station for observing radio signals and for developing new intercept equipment was established by the Army Ordnance Office at Hillersleben-Staats. There, an observation platoon was provided with the most recent laboratory equipment and was to conduct research in order to improve general intercept operations, antenna design, other D/F equipment, radar operations, and mechanical cryptanalytic devices. Based on the data derived from practical experience in the field, these experiments led to technical developments which enabled the Germans to keep pace with the latest enemy signal procedures. During the year 1944, for instance, twenty-four new techniques in enemy radio communication were observed and the development of corresponding countermeasures was immediately undertaken. At the experimental station the volume of recordings, which were made available

~~CONFIDENTIAL~~
~~Security Information~~

~~CONFIDENTIAL~~
~~Security Information~~

MS # P-038
App. VII

-251-

to the cryptanalysis and evaluation sections of the Armed Forces Cryptographic Branch and the Evaluation Control Center of OKH, averaged ten million transmissions a day. The existence of this experimental station made it possible to keep the Army Ordnance Office and private industry up to date on the requirements of the field forces. As a result, the equipment developed by the Germans incorporated the latest technical advances, corresponded to the wishes expressed by the user agencies, and kept pace with the enemy's most recent inventions and techniques.

~~CONFIDENTIAL~~
~~Security Information~~

~~CONFIDENTIAL~~
~~Security Information~~

MS # P-038

-252-

Appendix VIII

Transcript of an Intercept Made by the RI Unit of the
252d Infantry Division in the Gzhatsk Area on 24

February 1943

(Prepared from private records in the possession of
Colonel Leo Hepp)

Explanation of code designations:

- a. Napor: Russian radio operator at Leskino command post
- b. Upor: Russian artillery command post station
- c. Sorja: Russian radio operator at the command post of
supporting elements
- d. Kedr: Intermediate link between Napor, Upor, and Sorja
- e. Skowa: Russian radio operator at superior headquarters

Time

- 0453 Napor to Upor via Kedr: I am now at Vorobyevo. Contact me under 056.
- 0620 Napor to Skowa via Kedr: Move 44 (presumably reinforcements) to this
place immediately.
- 0700 Napor to Upor via Kedr: Direct supporting fire immediately 100 yards
west of Vorobyevo. 06 012 immediate reinforcements.
- 0705 Repetition of message transmitted at 0700 hours.
- 0707 Napor to Upor via Kedr: Enemy attacking. Direct artillery fire on
Klushino. Ammunition supply is low.

~~CONFIDENTIAL~~
~~Security Information~~

~~CONFIDENTIAL~~~~Security Information~~

MS # P-038
App. VIII

-253-

- 0730 Napor to Upor via Kedr: Enemy withdrawing from Klushino. Direct heavier fire on Klushino immediately.
- 0734 Napor to Upor via Kedr: Lift fire 550 yards. Fire one more salvo. Fire was right on target. Enemy evacuating Klushino.
- 0740 Napor to Upor via Kedr: Give immediate fire support, enemy attacking.
- 0747 Napor to Upor via Kedr: Lift fire 1500 yards on woods at 40 yards' distance from Vorobyevo. Urgently require artillery support.
- 0753 Napor to Upor via Kedr: Lift fire 450 yards urgently need fire!
- 0754 Upor to Napor via Kedr: State precisely where fire should really be directed. To Klushino or to Kusnetshiki?
- 0800 Napor to Upor via Kedr: Immediately direct artillery fire 100 yards west of Vorobyevo. Enemy attacking.
- 0810 Upor to Napor via Kedr: Nodov has left and brings needed supply (ammunition).
- 0815 Napor to Upor via Kedr: We urgently need reinforcements. Enemy attacking. We are out of ammunition.
- 0820 Upor to Napor via Kedr: How strong is attacking enemy force?
- 0821 Napor to Upor via Kedr: Enemy is far superior. Only a few of us left. I am alone at radio set.
- 0823 Napor to Upor via Kedr: We are throwing our last men into the fighting. Up to now no artillery fire has hit designated targets.
- 0830 Upor to Napor via Kedr: Vorobyevo must be held under all circumstances. Signed: 44.

~~CONFIDENTIAL~~~~Security Information~~

~~CONFIDENTIAL~~~~Security Information~~

MS # P-038
App. VIII

-254-

- 0835 Napor to Upor via Kedr: Fire steadily on western part of Vorobyevo.
Up to now I have not noticed any artillery fire.
- 0840 Napor to Upor via Kedr: I am at present/^{not}in Vorobyevo but in Leskino.
- 0848 Napor to Upor via Kedr: Enemy attacking from all sides. Fire should now be lifted 1,650 yards to the western edge of Leskino.
- 0853 Upor to Napor via Kedr: Which unit is actually in Vorobyevo and how is the situation there?
- 0857 Napor to Upor via Kedr: Enemy is again attacking from all sides.
- 0859 Napor to Upor via Kedr: Need immediate artillery support. Leskino is burning, there is house-to-house fighting.
- 0902 Napor to Upor via Kedr: Direct artillery fire 900 yards west of Leskino.
- 0904 Upor to Napor via Kedr: How greatly are you outnumbered by the enemy?
- 0906 Napor to Upor via Kedr: There are only a few men left and we are fighting for every house. Urgently request reinforcements and artillery support.
- 0910 Upor to Napor via Kedr: Immediately take up defensive position facing west until reinforcements arrive. Reinforcements will link up with you at the forester's house in the woods near Vorobyevo.
- 0912 Napor to Upor via Kedr: We will hold out to the last man.
- 0915 Napor to Upor via Kedr: Shells are on target; continue fighting in same manner.
- 0916 Upor to Napor via Kedr: Report immediately as soon as reinforcements have linked up with you.

~~CONFIDENTIAL~~~~Security Information~~

~~CONFIDENTIAL~~~~Security Information~~

MS # P-038
App. VIII

-255-

- 0925 Upor to Napor via Kedr: Who is with Kostarjev?
- 0926 Napor to Upor via Kedr: Kostarjev is wounded.
- 0928 Upor to Napor via Kedr: In what condition is Kostarjev and where is he?
- 0929 Napor to Upor via Kedr: He is under cover but does not leave the field of fire.
- 0930 Upor to Napor via Kedr: We shall start firing right away. Report precisely where shells hit.
- 0935 Napor to Upor via Kedr: I have not seen any artillery fire until now. Urgently need artillery support.
- 0945 Napor to Upor via Kedr: Direct fire on Leskino immediately. I am at the edge of the village.
- 0947 Upor to Napor via Kedr: I will fire immediately; report where shells hit.
- 0948 Napor to Upor via Kedr: I understand, I shall report where shells hit.
- 0950 Napor to Upor via Kedr: Shells are hitting target. Continue firing on the same target.
- 0955 Sorja to Napor via Kedr: We are advancing toward you in direction of Vorobyevo.
- 1005 Napor to Sorja via Kedr: Attack Vorobyevo immediately with one company. The remaining forces should link up with us.
- 1030 Sorja to Napor via Kedr: We are fighting our way through Yagorna (wooded area near Vorobyevo). We have suffered heavy losses from enemy fire. Only 30 and 40 men respectively are left of the two companies.

~~CONFIDENTIAL~~~~Security Information~~

~~CONFIDENTIAL~~~~Security Information~~

MS # P-038
App. VIII

-256-

- 1037 Upor to Napor via Kedr: From which direction is the enemy firing?
- 1039 Napor to Upor via Kedr: Give artillery support on Vorobyevo immediately. Kostarjev's group is fighting in the woods.
- 1043 Napor to Upor via Kedr: I am falling back on Vorobyevo. Enemy is firing on us from wooded area.
- 1045 Upor to Napor via Kedr: Report exactly where you are and where you want artillery fire to be placed. Bear in mind that our troops are in your rear.
- 1100 Napor to Upor via Kedr: Direct fire north of wooded area near Vorobyevo.
- 1135 Sorja to Napor via Kedr: The rations destined for you are now at the jump-off positions. We are awaiting your detail. Signed: Chochlov.
- 1142 Napor to Sorja via Kedr: Urgently request artillery support on Kusnetshiki. We are out of ammunition. Support did not arrive. Signed: Sokolov.
- 1143 Napor to Sorja via Kedr: We cannot send a ration detail because we are encircled.
- 1150 Upor to Napor via Kedr: You can pick up a storage battery for your radio.
- 1152 Napor to Upor via Kedr: We cannot pick up the storage battery either.
- 1153 Napor to Upor for Sorja via Kedr: Where are the reinforcements?
- 1200 Upor to Napor via Kedr: The reinforcements are at edge of the forest at Yagorna (near Vorobyevo).

~~CONFIDENTIAL~~~~Security Information~~

~~CONFIDENTIAL~~~~Security Information~~ES # P-038
App. VIII

-257-

- 1210 Napor to Upor via Kedr: What happened to artillery support?
- 1212 Napor to Upor via Kedr: We are still without artillery support.
Fire immediately on the village of Leskino.
- 1224 Napor to Upor via Kedr: Artillery fire! Artillery fire!
Artillery fire! On the village of Leskino.
- 1226 Napor to Upor via Kedr: Up to now only one shell has come over
and that was a dud.
- 1234 Napor to Upor via Kedr: Shells landing in northern part of the
village. Place fire 550 yards to the left. Every round is a dud.
- 1235 Napor to Upor via Kedr: We cannot fall back, we are surrounded.
- 1238 Upor to Napor via Kedr: Hold out until dusk, then attempt to break out.
- 1240 Napor to Upor via Kedr: We have only a few men left, but we shall
hold out.
- 1242 Napor to Upor via Kedr: Shells landing 450 yards north of village
of Leskino. Shift fire 200 yards to the rear and 200 yards further
left. Nothing but duds.
- 1245 Upor to Napor via Kedr: We are now firing shrapnel. Report exact
position of fire immediately.
- 1248 Upor to Napor via Kedr: Drutshenko has driven the Germans out of
their positions south of Leskino. Your orders are to take possession
of the Kussel area.
- 1304 Napor to Upor via Kedr: The first and third shells were well on the
target. Shift fire 350 yards to left and increase. Enemy is in
strong force.

~~CONFIDENTIAL~~~~Security Information~~

~~CONFIDENTIAL~~~~Security Information~~

MS # P-038
App. VIII

-258-

- 1306 Upor to Napor: From now on communicate directly. We are starting to fire.
- 1307 Napor to Upor: Shift fire 350 yards to left and 350 yards.
- 1310 Napor to Upor: We urgently need artillery support.
- 1317 Napor to Upor: Shift fire 450 yards to left and left 350 yards. immediately, because shells are landing on our own men.
- 1327 Upor to Napor: Report immediately where smaller caliber shells are hitting.
- 1332 Napor to Upor: Cease fire immediately, you are hitting our own positions.
- 1337 Napor to Upor: Can we count on support?
- 1343 Napor to Upor: Enemy attacking from all sides.
- 1344 Upor to Napor: You must hold out until dusk. Nothing else is possible.
- 1345 Napor to Upor: Cease fire immediately.
- 1400 Upor to Napor: Should I resume artillery support?
- 1435 Napor to Upor: Not at present.
- 1440 Napor to Upor: Direct fire on me immediately.
- 1445 Upor to Napor: Hold out until dusk. Then you will get some real help.
- 1448 Napor to Upor: Request immediate artillery support 450 yards to the right.
- 1449 Napor to Upor: We will hold out to the last man.

~~CONFIDENTIAL~~~~Security Information~~

~~CONFIDENTIAL~~~~Security Information~~

MS # P-038
App. VIII

-259-

- 1450 Upor to Napor: Inform Kesterovo that he has been awarded the Alexanderevski decoration. Congratulations from the commander of the 44th.
- 1457 Upor to Napor: Report exact impact area and necessary adjustment immediately.
- 1458 Napor to Upor: Lift fire 900 yards. There are no more duds among the shells.
- 1500 Napor to Upor: Enemy attacking with tanks.
- 1504 Upor to Napor: How far away from you are the tanks?
- 1505 Napor to Upor: The tanks are 100 yards from us. All our antitank weapons have been destroyed by the enemy.
- 1506 Upor to Napor: With what ammunition should we fire on the tanks?
- 1507 Napor to Upor: Fire on our positions immediately.
- 1508 Napor to Upor: Altogether we have only twenty men left.
- 1510 Napor to Upor: The tanks are coming closer and closer.
- 1524 Upor to Napor: Are the tanks advancing from the north or south?
- 1525 Napor to Upor: They are coming from the south. Fire quickly.
- 1534 Napor to Upor: The tanks are attacking from the south, the infantry from southwest. Fire more rapidly.
- 1538 Napor to Upor: More fire.
- 1538 Upor to Napor: The automatic gun cannot shoot that far. With what forces is the enemy attacking?
- 1539 Napor to Upor: With nine tanks and one infantry battalion.
- 1539 Upor to Napor: From which side is the battalion attacking?

~~CONFIDENTIAL~~~~Security Information~~

MS # P-038
App. VIII

-260-

1540 Napor to Upor: The houses are all burned down. Fire more rapidly.

1541 Napor to Upor: Shells landed well.

1542 Upor to Napor: If you get a chance withdraw to the east.

1543 Napor to Upor: Impossible! Fire more rapidly. If you give us more fire support, we can repulse the attacks.

1550 Napor to Upor: Heavier fire!

1600 Upor to Napor: We are firing more rapidly.

1603 Upor to Napor: Where did the shells land?

1604 Napor to Upor: Everything is confused. They are attacking from all sides.

1605 Upor to Napor: Where are Kosterov and Sokolov?

1606 Napor to Upor: I don't know where Kosterov is, Sokolov is dead.

1608 Upor to Napor: Totshinko and someone else will take care of you.

1610 Napor to Upor: Situation is very serious, the shells are exploding ten yards in front of us. Fire more rapidly. We are lost, all of us.

1626 Napor to Upor: What about help? From where can we expect help?

1628 Napor to Upor: This is the last time that I am calling!

1629 Upor to Napor: Destroy all documents! Be heroes!

1631 Napor to Upor: We are fighting to the last round. We still have two or three left.

1635 Napor to Upor: The only ones left are three radio operators. May we withdraw?

1636 Upor to Napor: Fight to the last, we shall not forget you. Give us the three names.

Napor failed to answer.

~~SECRET~~ A56970

~~CONFIDENTIAL~~

~~SECURITY INFORMATION~~

~~SECRET~~

~~CONFIDENTIAL~~

~~SECURITY INFORMATION~~

~~SECRET - SECURITY INFORMATION~~

29 April 1953

~~SECRET - SECURITY INFORMATION~~

MEMORANDUM FOR MR. FRIEDMAN

FROM: TEC

SUBJECT: MS Nr. P-038 "German Radio Intelligence", and the connection of AFSA and NSA therewith.

1. In February 1952, ASA requested AFSA to review subject manuscript. (Inclosure 1)
2. With Serial 00117, 20 February 1952, AFSA replied recommending deletion of certain portions considered to be "SECRET", if this document should be used, as proposed, for purposes of training. AFSA offered to assist in the recommended editing. (Inclosure 2.)
3. The Office of the Chief of Military History claims never to have received word of AFSA's objections, although ASA records show that the substance of AFSA's Serial 00117 was forwarded. The manuscript was printed and distributed in an edition of 1500 copies classified, "CONFIDENTIAL". Two hundred of these copies went hither and yon around Washington; the remaining 1300 copies were sent to the Signal Corps. Signal Corps (SCIA) held its copies, notified ASA, and on 26 September, ASA asked AFSA to mark the passages considered to be "SECRET". (Inclosure 3.)
4. The editing was carefully performed in consultation with Dr. Sinkov, Mr. Levenson, Mr. Young, and Dr. Shaw. All agreed there was no matter above "SECRET", but that several passages were indeed "SECRET". AFSA replied on 27 October 1952 in Serial 00794, suggesting upgrading to "SECRET". (Inclosure 4.)
5. On 12 December, Major Drenman, ASA, called this Division by phone. He stated that the Historical Division objected to the suggested upgrading. A general meeting was arranged.
6. This meeting was held at Historical Division on 16 December 1952. Among those present were:
 - Lt. Col. Helfers of the Historical Division.
 - Lt. Col. Masenga of SCIA
 - Maj. Drenman of ASA
 - Dr. R. W. Pettengill of NSA-18

~~SECRET SECURITY INFORMATION~~~~SECRET SECURITY INFORMATION~~

Historical Division objected to the proposed upgrading to "SECRET" on three principal grounds:

a. Historical Division claimed that AFSA's objection to publication as "CONFIDENTIAL" had not been received. The manuscript had been submitted to G-2 and Historical Division assumed G-2 had attended to coordinating with all other interested agencies. Fortunately, Major Drennan had with him his file showing that ASA had passed on AFSA's comments of 20 February. (See above).

b. Expense was great. Fifteen hundred copies had been printed with classification, "CONFIDENTIAL". When assured that 500 copies would be taken with "SECRET" classification, perturbation diminished, but it was still argued that upgrading was needless, since

c. In May and June 1952, General Praun had published in an unclassified German Army journal the substance of several of the passages AFSA had marked to be "SECRET". It was argued that U. S. authorities had no control over General Praun and his associates, that all of the "SECRET" passages might be printed in substance in the German press at any time.

NSA and ASA refused to budge and eventually the conferees agreed that the complete edition should be stamped, "SECRET" and that another, abridged, edition would be prepared for "CONFIDENTIAL" issue.

7. On 6 March 1953, 50 copies, stamped "SECRET", were received by NSA-18 and five of them were distributed to AFSS WEC/COO. In this connection, we know through Lt. Col. Helfers that the 200 copies were not recalled but that notices were sent requesting holders to upgrade to "SECRET". For an appreciable period, therefore, they were floating around marked only "CONFIDENTIAL".

8. No one of the NSA officials consulted outside this Division (see para. 4 above) recommended a classification above "SECRET". Each, however, independently concluded that a classification of "SECRET" was necessary. At the conference the ASA representative backed the NSA representative all the way; the SCIA representative went along by accepting "SECRET", but no higher.

9. It is a question whether Historical Division has published other items which might properly and profitably have been referred to this Agency for review.

J. T. PENDERGRASS
Commander, USN

Chief, Technical Information Division

4 Incls: a/s

- 2 - ~~SECRET~~

~~SECRET~~ SECURITY INFORMATION

12 February 1952

MEMORANDUM FOR CHIEF, TRAINING DIVISION:

SUBJECT: Transmittal of #P-038

1. This document with attached correspondence was submitted to this Office by the Operations Division, ASA, for information and evaluation, with the request that it be returned within five days.

2. It is forwarded herewith as a matter of primary interest to your Division. It is requested that you advise us as to its value to the Agency from the historical and training point of view, and that you return it to the Operations Division, ASA, as requested, when you have completed your review.

3. Your attention is invited to the fact that if you should feel that this document ought to be retained and processed for publication at AFSA, it will be necessary to arrange transfer of action in the matter from Production Division, G-2, Department of the Army, to AFSA through ASA.

/s/ B. PULLING, Col., USAF
Acting Chief
Office of Operations

3 Incls:

1. P-038
2. GAS 60 R.S. (Case No.2-81)
3. OM from DA, OAC/S, G-2 to GAS-60

C
O
P
Y

INCLOSURE I

~~SECRET~~

~~SECRET - SECURITY INFORMATION~~Serial: 00117
20 Feb 1952~~SECRET - SECURITY INFORMATION~~

SUBJECT: Return of MS #P-038

TO: Chief, Army Security Agency
The Pentagon

1. Subject manuscript is returned herewith.
2. The recommendation of Signal Corps Intelligence Agency that the attached document be reproduced as a training publication is concurred in. In general, the document should be classified "CONFIDENTIAL" but certain portions of the text would seem to require a classification of "SECRET". It is recommended that the "SECRET" material be deleted in order that the "CONFIDENTIAL" portion may be used more freely as training material. If desired, we will assist in the editing.
3. Request one copy each of the German and English test, if available.

FOR THE DIRECTOR:

/s/ GEO E. CAMPBELL
Colonel, AGC
Adjutant General

Incl: MS #P-038

cc: 11 (3)
Train Div (Comeback copy)
Ch, Off OperCapt. Dyer/60455/14/bhd/18 Feb 52
RE: HRPeterson/60219/AG/amp/19 Feb 52C
O
P
YINCLOSURE II~~SECRET~~

SECRET ~~SECURITY INFORMATION~~HEADQUARTERS
ARMY SECURITY AGENCY
Washington 25, D. C.

GAS 50 (319.1)

26 Sep 1952

SUBJECT: Department of the Army Manual MS No P-038, German Radio
Intelligence.TO: Director
Armed Forces Security Agency
Washington 25, D. C.
Attn: AFSA-252

1. Reference is made to letter, your Agency, Serial 00117,
subject: "Return of MS #P-038", dated 20 February 1952.
2. Inclosed herewith one (1) copy of Department of the Army
Manual MS #P-038, "German Radio Intelligence". This manual was
received from the Office of the Chief Signal Officer, Department of
the Army. That office is preparing to distribute the manual, and
prior to such distribution, has requested that the classification
of the document be reviewed.
3. In referenced letter (par 1 above), your Agency, in review-
ing manuscript of the manual, stated that certain portions of the
text would seem to require a classification of "SECRET" and/or
deleted. It is requested that this manual be reviewed by your Agency
and the sections thereof considered "SECRET" be marked as such on the
margin of the pages.
4. Because the manuals have already been printed by the Office
of Chief of Military History, Department of the Army, and are ready
for distribution, it is requested that the editing be expedited.

FOR THE CHIEF, ARMY SECURITY AGENCY

/s/ C. H. SIMCOX
Captain AGC
Asst. Adj. Gen.

1 Incl: a/s

C
O
P
Y

INCLOSURE III

~~SECRET~~

~~SECRET~~ ~~SECURITY INFORMATION~~Serial: 00117
27 Oct 1952~~SECRET~~ ~~SECURITY INFORMATION~~

SUBJECT: Return of MS #P-038

TO: Chief, Army Security Agency
The Pentagon

1. The historical study MS No. P-038 entitled GERMAN RADIO INTELLIGENCE, has been reviewed with interest. It is the opinion of the Armed Forces Security Agency that certain portions of the text call for a classification higher than "CONFIDENTIAL". These portions have been marked in the attached copy of the book.

2. It is suggested that the present edition be upgraded to "SECRET", be so stamped and be distributed primarily to those directly or indirectly concerned with signal or signal intelligence plans and policies.

3. It is further suggested that an abridgement be prepared for wider distribution with the classification "CONFIDENTIAL". This would mean the omission of passages marked in the attached copy and such minor changes in wording as may be necessary to avoid too abrupt transitions.

4. It is requested that the Armed Forces Security Agency be furnished fifty (50) copies of the complete edition and also fifty (50) copies of any abridged edition.

/s/ GEO E. CAMPBELL
Colonel, AGC
Adjutant General

2 Incls:

1. List of passages on sheet.
2. Copy of MS-P-038

C
O
P
Y

INCLOSURE IV

~~SECRET~~